

**M2S-X**

**ASUS**<sup>®</sup>

**Motherboard**

**E3081**

**Second Edition  
February 2007**

**Copyright © 2007 ASUSTeK COMPUTER INC. All Rights Reserved.**

No part of this manual, including the products and software described in it, may be reproduced, transmitted, transcribed, stored in a retrieval system, or translated into any language in any form or by any means, except documentation kept by the purchaser for backup purposes, without the express written permission of ASUSTeK COMPUTER INC. (“ASUS”).

Product warranty or service will not be extended if: (1) the product is repaired, modified or altered, unless such repair, modification or alteration is authorized in writing by ASUS; or (2) the serial number of the product is defaced or missing.

ASUS PROVIDES THIS MANUAL “AS IS” WITHOUT WARRANTY OF ANY KIND, EITHER EXPRESS OR IMPLIED, INCLUDING BUT NOT LIMITED TO THE IMPLIED WARRANTIES OR CONDITIONS OF MERCHANTABILITY OR FITNESS FOR A PARTICULAR PURPOSE. IN NO EVENT SHALL ASUS, ITS DIRECTORS, OFFICERS, EMPLOYEES OR AGENTS BE LIABLE FOR ANY INDIRECT, SPECIAL, INCIDENTAL, OR CONSEQUENTIAL DAMAGES (INCLUDING DAMAGES FOR LOSS OF PROFITS, LOSS OF BUSINESS, LOSS OF USE OR DATA, INTERRUPTION OF BUSINESS AND THE LIKE), EVEN IF ASUS HAS BEEN ADVISED OF THE POSSIBILITY OF SUCH DAMAGES ARISING FROM ANY DEFECT OR ERROR IN THIS MANUAL OR PRODUCT.

SPECIFICATIONS AND INFORMATION CONTAINED IN THIS MANUAL ARE FURNISHED FOR INFORMATIONAL USE ONLY, AND ARE SUBJECT TO CHANGE AT ANY TIME WITHOUT NOTICE, AND SHOULD NOT BE CONSTRUED AS A COMMITMENT BY ASUS. ASUS ASSUMES NO RESPONSIBILITY OR LIABILITY FOR ANY ERRORS OR INACCURACIES THAT MAY APPEAR IN THIS MANUAL, INCLUDING THE PRODUCTS AND SOFTWARE DESCRIBED IN IT.

Products and corporate names appearing in this manual may or may not be registered trademarks or copyrights of their respective companies, and are used only for identification or explanation and to the owners’ benefit, without intent to infringe.

# Contents

Notices .....	vi
Safety information .....	vii
About this guide.....	viii
Typography .....	ix
M2S-X specifications summary.....	x

## Chapter 1: Product introduction

1.1	Welcome! .....	1-2
1.2	Package contents .....	1-2
1.3	Special features .....	1-3
	1.3.1 Product highlights .....	1-3
	1.3.2 Unique ASUS features.....	1-4
1.4	Before you proceed .....	1-5
1.5	Motherboard overview .....	1-6
	1.5.1 Motherboard layout .....	1-6
	1.5.2 Placement direction .....	1-7
	1.5.3 Screw holes.....	1-7
1.6	Central Processing Unit (CPU) .....	1-8
	1.6.1 Overview .....	1-8
	1.6.2 Installing the CPU .....	1-8
	1.6.3 Installing the heatsink and fan .....	1-10
1.7	System memory.....	1-12
	1.7.1 DIMM sockets location .....	1-12
	1.7.2 Memory configurations .....	1-12
	1.7.3 Installing a DIMM .....	1-16
1.8	Expansion slots .....	1-16
	1.8.1 Standard interrupt assignments .....	1-17
	1.8.2 IRQ assignments for this motherboard .....	1-17
	1.8.3 PCI slots .....	1-18
	1.8.4 PCI Express x1 slot .....	1-18
	1.8.5 PCI Express x16 slot .....	1-18
1.9	Jumpers .....	1-19
1.10	Connectors .....	1-21
	1.10.1 Rear panel connectors .....	1-21
	1.10.2 Internal connectors.....	1-23

# Contents

## Chapter 2: BIOS setup

- 2.1 Managing and updating your BIOS ..... 2-2
  - 2.1.1 Creating a bootable floppy disk ..... 2-2
  - 2.1.2 Using AFUDOS to update the BIOS ..... 2-3
  - 2.1.3 Using AFUDOS to copy BIOS from PC ..... 2-4
  - 2.1.4 Using ASUS EZ Flash 2 to update the BIOS..... 2-5
  - 2.1.5 Recovering the BIOS with CrashFree BIOS 3 ..... 2-6
- 2.2 BIOS Setup program ..... 2-9
  - 2.2.1 BIOS menu screen ..... 2-10
  - 2.2.2 Menu bar ..... 2-10
  - 2.2.3 Navigation keys..... 2-10
  - 2.2.4 Menu items ..... 2-11
  - 2.2.5 Sub-menu items ..... 2-11
  - 2.2.6 Configuration fields ..... 2-11
  - 2.2.7 Pop-up window..... 2-11
  - 2.2.8 Scroll bar ..... 2-11
  - 2.2.9 General help ..... 2-11
- 2.3 Main menu..... 2-12
  - 2.3.1 System Time ..... 2-12
  - 2.3.2 System Date ..... 2-12
  - 2.3.3 Legacy Diskette A ..... 2-12
  - 2.3.4 Primary and Secondary IDE Master/Slave ..... 2-13
  - 2.3.5 SATA1 and SATA2..... 2-14
  - 2.3.6 IDE Configuration ..... 2-16
  - 2.3.7 System Information..... 2-17
- 2.4 Advanced menu ..... 2-17
  - 2.4.1 USB Configuration ..... 2-18
  - 2.4.2 JumperFree Configuration..... 2-19
  - 2.4.3 CPU Configuration ..... 2-20
  - 2.4.4 Chipset..... 2-20
  - 2.4.5 Onboard Devices Configuration..... 2-26
  - 2.4.6 PCI PnP..... 2-27

# Contents

2.5	Power menu .....	2-28
2.5.1	Suspend Mode.....	2-28
2.5.2	ACPI Version Features .....	2-28
2.5.3	ACPI APIC Support .....	2-28
2.5.4	APM Configuration .....	2-29
2.5.5	Hardware Monitor .....	2-30
2.6	Boot menu .....	2-31
2.6.1	Boot Device Priority .....	2-32
2.6.2	Boot Settings Configuration .....	2-32
2.6.3	Security.....	2-33
2.7	Tools menu .....	2-35
2.7.1	ASUS EZ Flash 2.....	2-35
2.8	Exit menu.....	2-36

## Chapter 3: Software support

3.1	Installing an operating system.....	3-2
3.2	Support CD information.....	3-2
3.2.1	Running the support CD.....	3-2
3.2.2	Drivers menu.....	3-3
3.2.3	Utilities menu .....	3-3
3.2.4	Make Disk.....	3-5
3.2.5	Manual .....	3-5
3.2.6	ASUS Contact information .....	3-6

# Notices

## Federal Communications Commission Statement

This device complies with Part 15 of the FCC Rules. Operation is subject to the following two conditions:

- This device may not cause harmful interference, and
- This device must accept any interference received including interference that may cause undesired operation.

This equipment has been tested and found to comply with the limits for a Class B digital device, pursuant to Part 15 of the FCC Rules. These limits are designed to provide reasonable protection against harmful interference in a residential installation. This equipment generates, uses and can radiate radio frequency energy and, if not installed and used in accordance with manufacturer's instructions, may cause harmful interference to radio communications. However, there is no guarantee that interference will not occur in a particular installation. If this equipment does cause harmful interference to radio or television reception, which can be determined by turning the equipment off and on, the user is encouraged to try to correct the interference by one or more of the following measures:

- Reorient or relocate the receiving antenna.
- Increase the separation between the equipment and receiver.
- Connect the equipment to an outlet on a circuit different from that to which the receiver is connected.
- Consult the dealer or an experienced radio/TV technician for help.



---

The use of shielded cables for connection of the monitor to the graphics card is required to assure compliance with FCC regulations. Changes or modifications to this unit not expressly approved by the party responsible for compliance could void the user's authority to operate this equipment.

---

## Canadian Department of Communications Statement

This digital apparatus does not exceed the Class B limits for radio noise emissions from digital apparatus set out in the Radio Interference Regulations of the Canadian Department of Communications.

**This class B digital apparatus complies with Canadian ICES-003.**

# Safety information

## Electrical safety

- To prevent electrical shock hazard, disconnect the power cable from the electrical outlet before relocating the system.
- When adding or removing devices to or from the system, ensure that the power cables for the devices are unplugged before the signal cables are connected. If possible, disconnect all power cables from the existing system before you add a device.
- Before connecting or removing signal cables from the motherboard, ensure that all power cables are unplugged.
- Seek professional assistance before using an adapter or extension cord. These devices could interrupt the grounding circuit.
- Make sure that your power supply is set to the correct voltage in your area. If you are not sure about the voltage of the electrical outlet you are using, contact your local power company.
- If the power supply is broken, do not try to fix it by yourself. Contact a qualified service technician or your retailer.

## Operation safety

- Before installing the motherboard and adding devices on it, carefully read all the manuals that came with the package.
- Before using the product, make sure all cables are correctly connected and the power cables are not damaged. If you detect any damage, contact your dealer immediately.
- To avoid short circuits, keep paper clips, screws, and staples away from connectors, slots, sockets and circuitry.
- Avoid dust, humidity, and temperature extremes. Do not place the product in any area where it may become wet.
- Place the product on a stable surface.
- If you encounter technical problems with the product, contact a qualified service technician or your retailer.



---

The symbol of the crossed out wheeled bin indicates that the product (electrical and electronic equipment) should not be placed in municipal waste. Check local regulations for disposal of electronic products.

---

# About this guide

This user guide contains the information you need when installing and configuring the motherboard.

## How this guide is organized

This manual contains the following parts:

- **Chapter 1: Product introduction**  
This chapter describes the features of the motherboard and the new technology it supports. This chapter also lists the hardware setup procedures that you have to perform when installing system components. It includes description of the jumpers and connectors on the motherboard.
- **Chapter 2: BIOS setup**  
This chapter tells how to change system settings through the BIOS Setup menus. Detailed descriptions of the BIOS parameters are also provided.
- **Chapter 3: Software support**  
This chapter describes the contents of the support CD that comes with the motherboard package.

## Where to find more information

Refer to the following sources for additional information and for product and software updates.

### 1. ASUS websites

The ASUS website provides updated information on ASUS hardware and software products. Refer to the ASUS contact information.

### 2. Optional documentation

Your product package may include optional documentation, such as warranty flyers, that may have been added by your dealer. These documents are not part of the standard package.



## Conventions used in this guide

To make sure that you perform certain tasks properly, take note of the following symbols used throughout this manual.



**DANGER/WARNING:** Information to prevent injury to yourself when trying to complete a task.



**CAUTION:** Information to prevent damage to the components when trying to complete a task.



**IMPORTANT:** Instructions that you **MUST** follow to complete a task.



**NOTE:** Tips and additional information to help you complete a task.

## Typography

### **Bold text**

Indicates a menu or an item to select

*Italics*

Used to emphasize a word or a phrase

<Key>

Keys enclosed in the less-than and greater-than sign means that you must press the enclosed key

Example: <Enter> means that you must press the Enter or Return key

<Key1>+<Key2>+<Key3>

If you must press two or more keys simultaneously, the key names are linked with a plus sign (+)

Example: <Ctrl>+<Alt>+<D>

### **Command**

Means that you must type the command exactly as shown, then supply the required item or value enclosed in brackets

Example: At the DOS prompt, type the command line:

```
afudos /i [filename]  
afudos /iM2S-X.ROM
```

# M2S-X specifications summary

<b>CPU</b>	Socket AM2 for AMD Athlon™ 64 FX/AMD Athlon™ 64 X2 /AMD Athlon 64™/AMD Sempron™ processors Supports AMD Cool 'n' Quiet™ Technology AMD64 architecture enables simultaneous 32-bit and 64-bit computing AMD Live!™ ready
<b>Chipset</b>	SIS® 756 SIS® 965L
<b>System bus</b>	2000 / 1600 MT/s
<b>Memory</b>	Dual-channel memory architecture <ul style="list-style-type: none"> <li>- 4 x 240-pin DIMM sockets support unbuffered ECC/non-ECC DDR2 800/667/533 MHz memory modules</li> <li>- Supports up to 4 GB system memory</li> </ul>
<b>Expansion slots</b>	1 x PCI Express™ x16 slot 2 x PCI Express™ x1 slots 3 x PCI 2.2 slots
<b>Storage</b>	2 x Ultra DMA 133/100/66/33 2 x SATA support RAID 0, 1, and JBOD
<b>LAN</b>	Realtek® RTL8201CL 10/100 LAN
<b>Audio</b>	C-Media Superior Quality Audio 7.1 channel audio CODEC Supports S/PDIF Out interface
<b>USB</b>	Supports up to 6 USB 2.0 ports (two at mid-board, four on the rear panel)
<b>ASUS special features</b>	ASUS C.P.R. ASUS MyLogo ASUS CrashFree BIOS 3 ASUS EZ Flash 2 ASUS Q-Fan SFS (Stepless Frequency Selection) from 200MHz up to 400MHz at 1MHz increment
<b>Rear panel</b>	1 x Parallel port 1 x PS/2 keyboard port (purple) 1 x PS/2 mouse port (green) 1 x Serial port 1 x S/PDIF Out port (Coaxial) 1 x LAN (RJ-45) ports 4 x USB 2.0/1.1 ports 8-channel audio I/O ports

*(continued on the next page)*

## M2S-X specifications summary

<b>Internal connectors</b>	1 x USB 2.0 connector supports additional 2 USB 2.0 ports 1 x Floppy disk drive connector 2 x IDE connector 2 x Serial ATA connectors 1 x CPU fan / 1 x Chassis fan 1 x Chassis intrusion connector 1 x S/PDIF out header connector Front panel audio connector CD audio in connectors 24-pin ATX power connector 4-pin ATX 12 V power connector System panel connector
<b>BIOS features</b>	4 Mb Flash ROM, AMI BIOS, PnP, DMI 2.0, WfM2.0, SM BIOS 2.3, ACPI 2.0a, ASUS EZ Flash 2, ASUS CrashFree BIOS 3
<b>Manageability</b>	WfM 2.0, DMI 2.0, WOL by PME, WOR by PME, PXE
<b>Accessories</b>	UltraDMA cable FDD cable SATA cable SATA power cable I/O Shield User's manual
<b>Support CD contents</b>	Drivers ASUS PC Probe II ASUS Update Anti-virus software (OEM version)
<b>Form factor</b>	ATX form factor: 12 in x 8.6 in (30.5 cm x 21.8 cm)

*\*Specifications are subject to change without notice.*



This chapter describes the motherboard features and the new technologies it supports.

# 1 Product introduction

## 1.1 Welcome!

**Thank you for buying an ASUS® M2S-X motherboard!**

The motherboard delivers a host of new features and latest technologies, making it another standout in the long line of ASUS quality motherboards!

Before you start installing the motherboard, and hardware devices on it, check the items in your package with the list below.

## 1.2 Package contents

Check your motherboard package for the following items.

<b>Motherboard</b>	ASUS M2S-X motherboard
<b>Cables</b>	1 x Ultra DMA cable 1 x SATA power cable 1 x SATA signal cable 1 x Floppy disk cable
<b>Accessories</b>	I/O shield
<b>Application CDs</b>	ASUS motherboard support CD
<b>Documentation</b>	User guide



If any of the above items is damaged or missing, contact your retailer.

## 1.3 Special features

### 1.3.1 Product Highlights

#### Latest processor technology

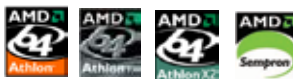

The motherboard comes with a 940-pin AM2 socket that supports AMD Athlon™ 64 FX/AMD Athlon™ 64 X2/AMD Athlon™ 64/AMD Sempron™ processors. With an integrated low-latency high-bandwidth memory controller and a highly scalable HyperTransport™ technology-based system bus, the motherboard provides a powerful platform for your diverse computing needs, increased office productivity, and enhanced digital media experience.

#### HyperTransport™ Technology



HyperTransport™ Technology is a high-speed, low latency, point-to-point link designed to increase the communication speed between integrated circuits in computers, networking and telecommunications equipment up to 48 times faster than other existing technologies.

#### Cool 'n' Quiet!™ Technology



The motherboard supports the AMD® Cool 'n' Quiet!™ Technology that dynamically and automatically changes the CPU speed, voltage and amount of power depending on the task the CPU performs.

#### Serial ATA RAID solution



The motherboard provides a high-performance Serial ATA RAID controller that enhance hard disk performance and data backup protection without the cost of additional RAID cards. The onboard SIS 965L RAID controller provides two Serial ATA connectors for RAID 0, RAID 1 and JBOD functions.

#### S/PDIF out



The motherboard's S/PDIF out function turns your computer into a high-end entertainment system with digital connectivity to powerful speaker systems.

#### PCI Express™ interface



The motherboard fully supports PCI Express, the latest I/O interconnect technology that speeds up the PCI bus. PCI Express features point-to-point serial interconnections between devices and allows higher clockspeeds by carrying data in packets. This high speed interface is software compatible with existing PCI specifications.

## 1.3.2 Unique ASUS features

### CrashFree BIOS 3

The ASUS CrashFree BIOS 3 allows users to restore corrupted BIOS data from a USB flash disk containing the BIOS file. This utility saves users the cost and hassle of buying a replacement BIOS chip.

### C.P.R. (CPU Parameter Recall)

The C.P.R. feature of the motherboard BIOS allows automatic re-setting to the BIOS default settings in case the system hangs due to overclocking. When the system hangs due to overclocking, C.P.R. eliminates the need to open the system chassis and clear the RTC data. Simply shut down and reboot the system, and BIOS automatically restores the CPU previous setting for each parameter.

### ASUS MyLogo™

This new feature present in the motherboard allows you to personalize and add style to your system with customizable boot logos.

### ASUS EZ Flash 2

EZ Flash 2 is a user-friendly BIOS update utility. Simply press the predefined hotkey to launch the utility and update the BIOS without entering the OS. Update your BIOS easily without preparing a bootable diskette or using an OS-based flash utility.

### ASUS Q-Fan technology

The ASUS Q-Fan technology smartly adjusts the fan speeds according to the system loading to ensure quiet, cool, and efficient operation.



## 1.4 Before you proceed

Take note of the following precautions before you install motherboard components or change any motherboard settings.



- Unplug the power cord from the wall socket before touching any component.
- Use a grounded wrist strap or touch a safely grounded object or to a metal object, such as the power supply case, before handling components to avoid damaging them due to static electricity
- Hold components by the edges to avoid touching the ICs on them.
- Whenever you uninstall any component, place it on a grounded antistatic pad or in the bag that came with the component.
- **Before you install or remove any component, ensure that the ATX power supply is switched off or the power cord is detached from the power supply.** Failure to do so may cause severe damage to the motherboard, peripherals, and/or components.

### Onboard LED

The motherboard comes with a green standby power LED that lights up to indicate that the system is ON, in sleep mode, or in soft-off mode. This is a reminder that you should shut down the system and unplug the power cable before removing or plugging in any motherboard component.

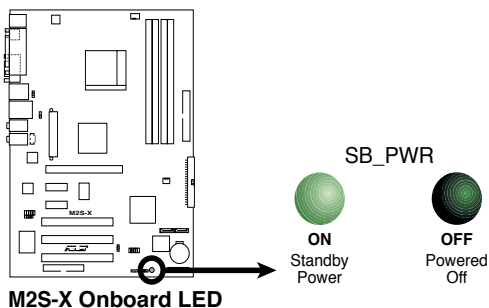

# 1.5 Motherboard overview

## 1.5.1 Motherboard layout

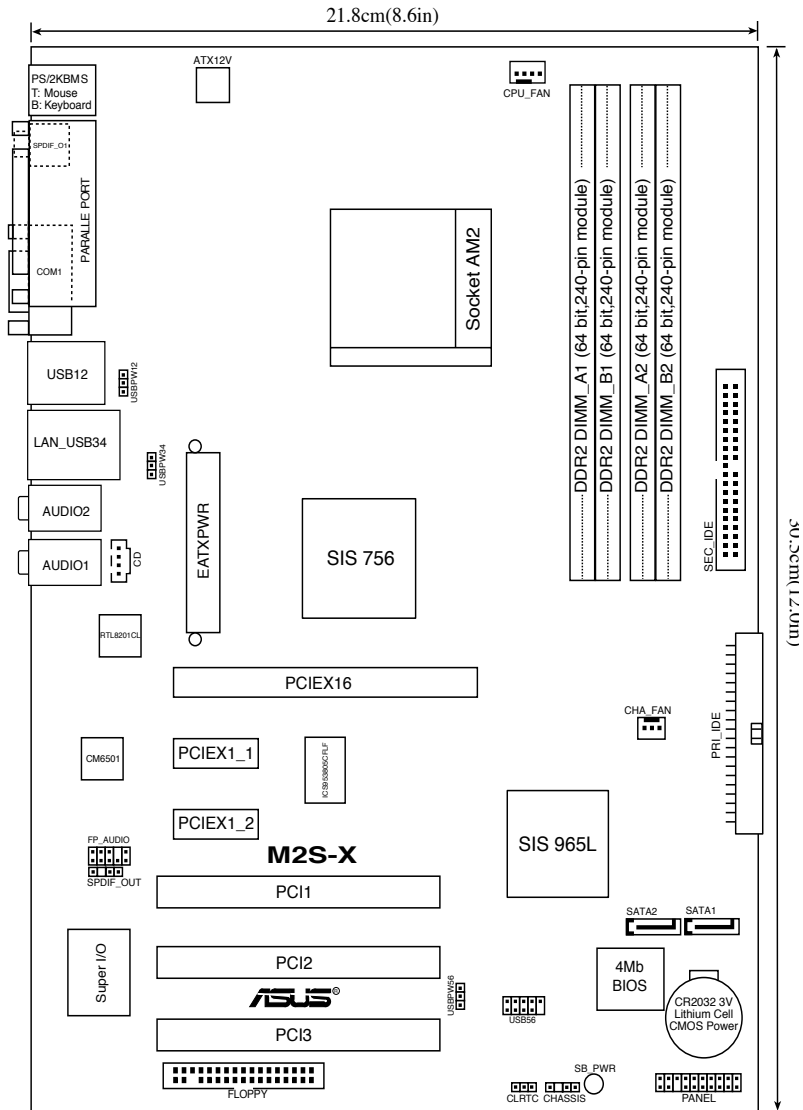

## 1.5.2 Placement direction

When installing the motherboard, make sure that you place it into the chassis in the correct orientation. The edge with external ports goes to the rear part of the chassis as indicated in the image below.

## 1.5.3 Screw holes

Place six (6) screws into the holes indicated by circles to secure the motherboard to the chassis.



Do not overtighten the screws! Doing so may damage the motherboard.

Place this side towards  
the rear of the chassis

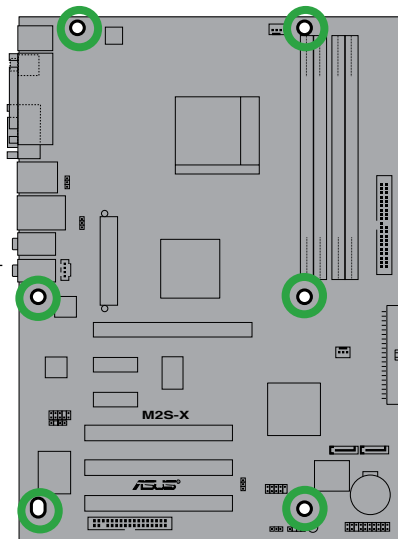

Before you install the motherboard, study the configuration of your chassis to ensure that the motherboard fits into it.



Make sure to unplug the power cord before installing or removing the motherboard. Failure to do so can cause you physical injury and damage motherboard components.

# 1.6 Central Processing Unit (CPU)

## 1.6.1 Overview

The motherboard comes with a surface mount 940-pin AM2 socket designed for the AMD Athlon™ 64, AMD Athlon™ 64 X2, AMD Athlon™ 64 FX, and AMD Sempron™ Processors.

Take note of the marked corner (with gold triangle) on the CPU. This mark should match a specific corner on the socket to ensure correct installation.

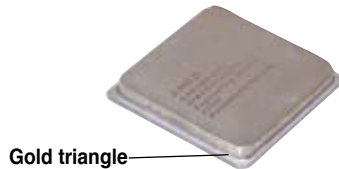

## 1.6.2 Installing the CPU

To install a CPU:

1. Locate the CPU socket on the motherboard.

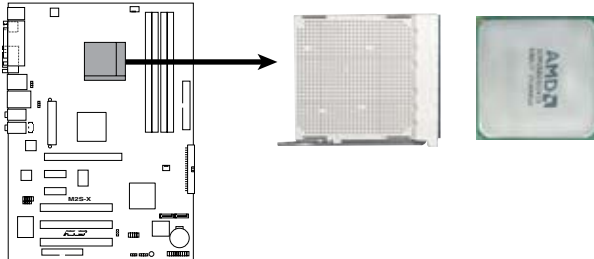

**M2S-X CPU Socket M2**



Before installing the CPU, make sure that the socket box is facing towards you and the load lever is on your left.



Incorrect installation of the CPU into the socket may bend the pins and severely damage the CPU!

2. Unlock the socket by pressing the lever sideways, then lift it up to a 90°-100° angle.

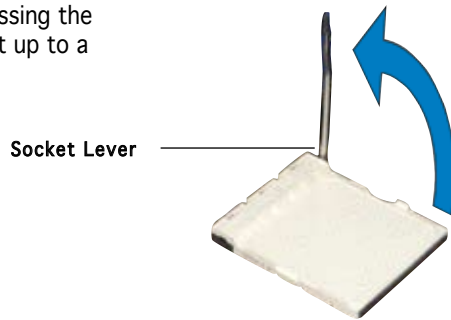

---

Make sure that the socket lever is lifted up to 90°-100° angle, otherwise the CPU does not fit in completely.

---

3. Position the CPU above the socket such that the CPU corner with the gold triangle matches the socket corner with a small triangle.
4. Carefully insert the CPU into the socket until it fits in place.

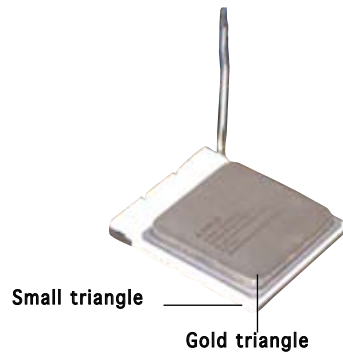

---

The CPU fits only in one correct orientation. DO NOT force the CPU into the socket to prevent bending the pins and damaging the CPU!

---

5. When the CPU is in place, push down the socket lever to secure the CPU. The lever clicks on the side tab to indicate that it is locked.
6. Install specifically designed heatsink and fan assembly.



### 1.6.3 Installing the heatsink and fan

The AMD Athlon™ 64, AMD Athlon™ 64 X2, AMD Athlon™ 64 FX, or AMD Sempron™ processors require a specially designed heatsink and fan assembly to ensure optimum thermal condition and performance.



---

Make sure that you use only qualified heatsink and fan assembly.

---

Follow these steps to install the CPU heatsink and fan.

1. Place the heatsink on top of the installed CPU, making sure that the heatsink fits properly on the retention module base.



- The retention module base is already installed on the motherboard upon purchase.
  - You do not have to remove the retention module base when installing the CPU or installing other motherboard components.
  - If you purchased a separate CPU heatsink and fan assembly, make sure that a Thermal Interface Material is properly applied to the CPU heatsink or CPU before you install the heatsink and fan assembly.
- 

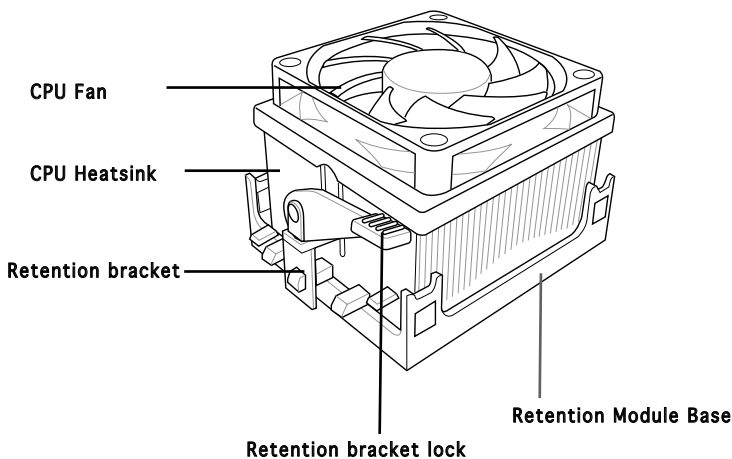

---

Your boxed CPU heatsink and fan assembly should come with installation instructions for the CPU, heatsink, and the retention mechanism. If the instructions in this section do not match the CPU documentation, follow the latter.

---

2. Attach one end of the retention bracket to the retention module base.

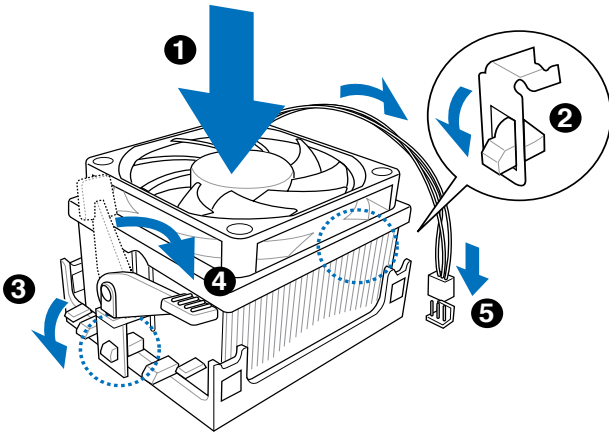

3. Align the other end of the retention bracket (near the retention bracket lock) to the retention module base. A clicking sound denotes that the retention bracket is in place.



Make sure that the fan and heatsink assembly perfectly fits the retention mechanism module base, otherwise you cannot snap the retention bracket in place.

4. Push down the retention bracket lock on the retention mechanism to secure the heatsink and fan to the module base.
5. When the fan and heatsink assembly is in place, connect the CPU fan cable to the connector on the motherboard labeled CPU\_FAN.

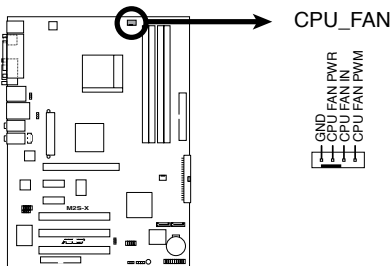

**M2S-X CPU Fan Connector**



Do not forget to connect the CPU fan connector! Hardware monitoring errors can occur if you fail to plug this connector.

## 1.7 System memory

### 1.7.1 DIMM sockets location

The following figure illustrates the location of the DDR2 DIMM sockets.

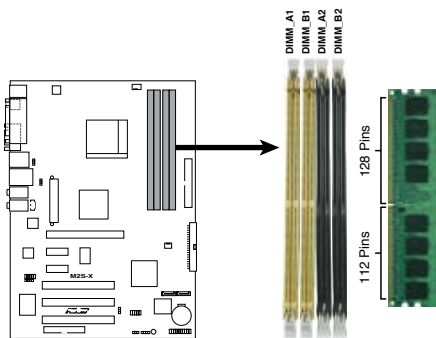

**M2S-X 240-pin DDR2 DIMM Sockets**



- Make sure to unplug the power supply before adding or removing DIMMs or other system components. Failure to do so may cause severe damage to both the motherboard and the components.
- We recommend to install the memory modules first before installing a PCI Express x16 card.

### 1.7.2 Memory configurations

You may install 256MB, 512MB, 1GB, and 2GB unbuffered ECC/non-ECC DDR2 DIMMs into the DIMM sockets.

### Recommended Memory Configurations

Mode	Sockets			
	DIMM_A1	DIMM_B1	DIMM_A2	DIMM_B2
Single Channel	Populated	-	-	-
	-	-	Populated	-
	-	Populated	-	-
	-	-	-	Populated
Dual-channel (1)	Populated	Populated	-	-
	-	-	Populated	Populated
Dual-channel (2)	Populated	Populated	Populated	Populated





- 
- \* For dual-channel memory configuration (2), you may:
    - install identical DIMMs in all four sockets OR
    - install an identical DIMM pair in DIMM\_A1 and DIMM\_B1 (yellow sockets) and another identical DIMM pair in DIMM\_A2 and DIMM\_B2 (black sockets)
  
  - \* Always use identical DDR2 DIMM pairs for dual-channel model. For optimum compatibility, we recommend that you obtain memory modules from the same vendor. Visit the ASUS website ([www.asus.com](http://www.asus.com)) for the latest Qualified Vendors List.
- 



### Important notice on installing Windows® XP 32-bit version

If you install Windows® XP 32-bit version Operating System (OS), the limitation of this OS version is that it may reserve a certain amount of memory space for system devices. We recommend that you install less than 3 GB system memory if you would like to work under Windows® XP 32-bit version OS. The excess memory installation will not cause any usage problem, but it will not give users the benefit of manipulating this excess memory space.

Visit the ASUS FAQ site for further explanation:

<http://support.asus.com/faq/faq.aspx?SLanguage=en-us>

Under General Search, make the selections as shown, then click Search. Click the article titled “4GB memory installed but less memory size detected.”



You also may check the URLs below for third party comments on this issue:

[http://dlsvr01.asus.com/pub/ASUS/mb/4GB\\_Rev1.pdf](http://dlsvr01.asus.com/pub/ASUS/mb/4GB_Rev1.pdf)

<http://www.intel.com/support/motherboards/server/sb/cs-016594.htm>

Due to chipset limitation, this motherboard can only support up to 3 GB on the 64-bit operating systems.

---

## DDR2 800 Qualified Vendors List

Size	Vendor	Model	SS/DS	Component	DIMM support		
					A	B	C
512MB	Kingston	KVR800D2N5/512	SS	K4T51083QC-ZCE7	v	v	v
512MB	Kingston	KVR800D2N5/512	SS	V59C1512804QBF25S0054707PEBPA	v	v	v
1G	Kingston	KVR800D2N5/1G	DS	K4T51083QC-ZCE7	v	v	v
1G	Kingston	KHX6400D2LL/1G	DS	Heat-Sink Package	v	v	v
1G	Kingston	KVR800D2N5/1G	DS	NT5TU64M8BE-25C62321800CP	v	v	v
512MB	Samsung	KR M378T6553CZ3-CE7	SS	K4T51083QC-ZCE7	v	v	v
1G	Samsung	KR M378T2953CZ3-CE7	DS	K4T51083QC-ZCE7	v	v	v
512MB	Samsung	KR M391T6553CZ3-CE7	SS	K4T51083QC-ZCE7(ECC)	v	v	v
1G	Samsung	KR M391T2953CZ3-CE7	DS	K4T51083QC-ZCE7(ECC)	v	v	v
256MB	Qimonda	HYS64T32001HU-2.5-A	SS	HYB18T256800AF25SSS49313	v	v	v
512MB	Qimonda	HYS64T64020HU-2.5-A	DS	HYB18T256800AF25SSS25063	v	v	v
512MB	Micron	MT9HTF6472AY-80ED4	SS	6ED22D9GKX(ECC)	v	v	v
512MB	Corsair	CM2X512A-6400	SS	Heat-Sink Package	v	v	v
1G	Corsair	CM2X1024-6400	DS	Heat-Sink Package	v	v	v
512MB	HY	HYMP564U64AP8-S6 AA	SS	HY5PS12821AFP-S6	v	v	v
512MB	HY	HYMP564U64BP8-S5 AB	SS	HY5PS12821BFP-S5	v	v	v
1G	HY	HYMP512U64AP8-S6 AA	DS	HY5PS12821AFP-S6	v	v	v
1G	HY	HYMP512U64BP8-S5 AB	DS	HY5PS12821BFP-S5	v	v	v
512MB	VDATA	M2GVD6G3H31601E53	SS	VD29608A8A-25EG30648	v	v	v
1G	VDATA	M2GVD6G341701E53	DS	VD29608A8A-25EG30647	v	v	v

## DDR2 667 Qualified Vendors List

Size	Vendor	Model	SS/DS	Component	DIMM support		
					A	B	C
256MB	Kingston	KVR667D2N5/256	SS	E2508AB-6E-E	v	v	v
512MB	Kingston	KVR667D2N5/512	SS	D6408TE8WL-27	v	v	v
512MB	Kingston	KVR667D2E5/512	SS	E5108AE-6E-E(ECC)	v	v	v
1G	Kingston	KVR667D2N5/1G	DS	D6408TE8WL-3	v	v	v
512MB	Samsung	KR M378T6553CZ0-CE6	SS	K4T51083QC	v	v	v
512MB	Samsung	KR M378T6453FZ0-CE6	DS	K4T56083QF-ZCE6	v	v	v
512MB	Samsung	M378T6553CZ3-CE6	SS	K4T51083QC-ZCE6	v	v	v
1G	Samsung	M378T2953CZ3-CE6	DS	K4T51083QC-ZCE6	v	v	v
1G	Samsung	KR M378T2953CZ0-CE6	DS	K4T51083QC-ZCE6	v	v	v
256MB	Qimonda	HYS64T32000HU-3S-A	SS	HYB18T512160AF-3SSSS17310	v	v	v
512MB	Qimonda	HYS64T32000HU-3S-A	SS	HYB18T5128000AF-3SSSS27416v	v	v	v
512MB	Qimonda	HYS64T64000HU-3S-A	SS	HYB18T512800AF3SFSS05346	v	v	v
1G	Qimonda	HYS64T128020HU-3S-A	DS	HYB18T512800AF3SSSS28104	v	v	v
512MB	Corsair	CM2X512-5400C4	SS	Heat-Sink Package	v	v	v
1G	Corsair	VS1GB667D2	DS	MID095D62864M8CEC	v	v	v
512MB	HY	HYMP564U64AP8-Y4 AA	SS	HY5PS12821AFP-Y4	v	v	v
512MB	HY	HYMP564U64AP8-Y5 AA	SS	HY5PS12821AFP-Y5	v	v	v
512MB	HY	HYMP564U72AP8-Y4	SS	HY5PS12821AFP-Y4(ECC)	v	v	v
512MB	HY	HYMP564U72AP8-Y5	SS	HY5PS12821AFP-Y5(ECC)	v	v	v

## DDR2 667 Qualified Vendors List

Size	Vendor	Model	SS/DS	Component	DIMM support		
					A	B	C
1G	HY	HYMP512U72AP8-Y5	DS	HY5PS12821AFP-Y5(ECC)	v	v	v
1G	HY	HYMP512U64AP8-Y5 AB	DS	HY5PS12821AFP-Y5	v	v	v
512MB	Kingmax	KLCC28F-A8EB5	SS	E5108AE-6E-E	v	v	v
512MB	Kingmax	KLCC28F-A8KB5	SS	KKEA88B4LAUG-29DX	v	v	v
1G	Kingmax	KLCD48F-A8KB5	DS	KKEA88B4LAUG-29DX	v	v	v
512MB	Apacer	78.91092.420	SS	E5108AE-6E-E	v	v	v
512MB	Apacer	AU512E667C5KBGC	SS	AM4B5708MJS7E0627B	v	v	v
512MB	Apacer	AU512E667C5KBGC	SS	AM4B5708GQS7E06332F	v	v	v
1G	Apacer	AU01GE667C5KBGC	DS	AM4B5708GQS7E0636B	v	v	v
1G	Apacer	78.01092.420	DS	E5108AE-6E-E	v	v	v
1G	Apacer	AU01GE667C5KBGC	DS	AM4B5708MJS7E0627B	v	v	v
512MB	ADATA	M20EL5G3H3160B1C0Z	SS	E5108AE-6E-E	v	v	v
512MB	ADATA	M20AD5G3H3166I1C52	SS	AD29608A8A-3EG20648	v	v	v
1G	ADATA	M20AD5G3I4176I1C52	DS	AD29608A8A-3EG20645	v	v	v
512MB	VDATA	M2GVD5G3H31A4I1C52	SS	D29608A8A-3EC20615	v	v	v
512MB	VDATA	M2YVD5G3H31P4I1C52	SS	VD29608A8A-3EG20627	v	v	v
512MB	VDATA	M2GVD5G3H166I1C52	SS	VD29608A8A-3EG20637	v	v	v
1G	VDATA	M2GVD5G3I41P6I1C52	DS	VD29608A8A-3EG20627	v	v	v
1G	VDATA	M2GVD5G3I41C4I1C52	DS	VD29608A8A-3EC20620	v	v	v
1G	VDATA	M2GVD5G3I4176I1C52	DS	VD29608A8A-3EG20641	v	v	v

## DDR2 533 Qualified Vendors List

Size	Vendor	Model	SS/DS	Component	DIMM support		
					A	B	C
256MB	Kingston	KVR533D2N4/256	SS	E5116AB-5C-E	v	v	v
256MB	Kingston	KVR533D2N4/256	SS	E5116AF-5C-E	v	v	v
512MB	Kingston	KVR533D2N4/512	DS	HY5PS56821F-C4	v	v	v
512MB	Kingston	KVR533D2N4/512	SS	HYB18T512800AF3733336550	v	v	v
1G	Kingston	KVR533D2N4/1G	DS	D6408TE7BL-37	v	v	v
1G	Kingston	KVR533D2N4/1G	DS	5YD11D9GCT	v	v	v
256MB	Samsung	M378T3253FG0-CD5	SS	K4T56083QF-GCD5	v	v	v
512MB	Samsung	M378T6553BG0-CD5	SS	K4T51083QB-GCD5	v	v	v
512MB	Qimonda	HYS64T64000GU-3.7-A	SS	HYB18T512800AC37SSS11511	v	v	v
512MB	Qimonda	HYS64T64000HU-3.7-A	SS	HYB18T512800AF37FSS29334	v	v	v
512MB	Micron	MT 16HTF6464AG-53EB2	DS	D9B0M	v	v	v
1G	Micron	MT 16HTF12864AY-53EA1	DS	D9CRZ	v	v	v
512MB	Corsair	V5S12MB533D2	DS	MII0052532M8CEC	v	v	v
512MB	Elpida	EBE51UD8ABFA-5C-E	SS	E5108AB-5C-E	v	v	v
512MB	Transcend	512MB DDR2 533 ECC	SS	6ND22D9GCT(ECC)	v	v	v
512MB	Kingmax	KLBC28F-A8KB4	SS	KKEA88B4IAK-37	v	v	v
256MB	Kingmax	KLBB68F-36EP4	SS	E5116AB-5C-E	v	v	v
512MB	Kingmax	KLBC28F-A8EB4	SS	E5108AE-5C-E	v	v	v

**Side(s):** **SS** - Single-Sided

**DS** - Double-Sided

**DIMM Support:**

- A - supports one module inserted in any slot as Single-channel memory configuration.
- B - supports on pair of modules inserted into either the yellow slots or the black slots as one pair of Dual-channel memory configuration.
- C - supports 4 modules inserted into both the yellow and black slots as two pairs of Dual-channel memory configuration.



Visit the ASUS website ([www.asus.com](http://www.asus.com)) for the latest Qualified Vendors List.

### 1.7.3 Installing a DIMM

Follow these steps to install a DIMM.

1. Unlock a DIMM socket by pressing the retaining clips outward.
2. Align a DIMM on the socket such that the notch on the DIMM matches the break on the socket.
3. Firmly insert the DIMM into the socket until the retaining clips snap back in place and the DIMM is properly seated.

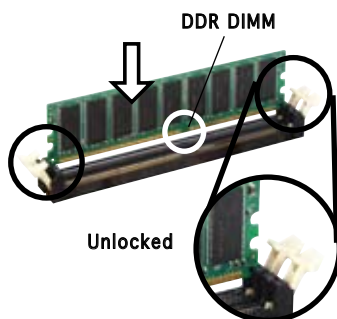

A DDR2 DIMM is keyed with a notch so that it fits in only one direction. DO NOT force a DIMM into a socket to avoid damaging the DIMM.

## 1.8 Expansion slots

To install and configure an expansion card:

1. Install an expansion card following the instructions that came with the chassis.
2. Turn on the system and change the necessary BIOS settings, if any, See Chapter 2 for BIOS information.
3. Assign an IRQ to the card. Refer to the tables next page.
4. Install the drivers and/or software applications for the expansion card according to the card documentation.

## 1.8.1 Standard interrupt assignments

IRQ	Priority	Standard Function
0	1	System Timer
1	2	Keyboard Controller
2	N/A	Programmable Interrupt
3*	11	IRQ holder for PCI steering
4*	12	Communications Port (COM1)
5*	13	IRQ holder for PCI steering
6	14	Floppy Disk Controller
7*	15	Printer Port (LPT1)
8	3	System CMOS/Real Time Clock
9*	4	IRQ holder for PCI steering
10*	5	IRQ holder for PCI steering
11*	6	IRQ holder for PCI steering
12*	7	PS/2 Compatible Mouse Port
13	8	Numeric Data Processor
14*	9	Primary IDE Channel
15*	10	Secondary IDE Channel

\* These IRQs are usually available for PCI devices.

## 1.8.2 IRQ assignments for this motherboard

	A	B	C	D	E	F	G	H
PCI slot 1	shared	—	—	—	—	—	—	—
PCI slot 2	—	shared	—	—	—	—	—	—
PCI slot 3	—	—	shared	—	—	—	—	—
PCIe x1 slot 1	shared	—	—	—	—	—	—	—
PCIe x1 slot 2	shared	—	—	—	—	—	—	—
PCIe x16 slot	shared	—	—	—	—	—	—	—
Onboard USB controller 1	—	—	—	—	used	—	—	—
Onboard USB controller 2	—	—	—	—	—	used	—	—
Onboard USB controller 3	—	—	—	—	—	—	used	—
Onboard USB 2.0 controller	—	—	—	—	—	—	—	used
Onboard LAN	—	—	—	used	—	—	—	—
Onboard Audio	—	—	shared	—	—	—	—	—
Serial ATA	—	shared	—	—	—	—	—	—



When using PCI cards on shared slots, ensure that the drivers support “Share IRQ” or that the cards do not need IRQ assignments. Otherwise, conflicts will arise between the two PCI groups, making the system unstable and the card inoperable.

### 1.8.3 PCI slots

The PCI slots support PCI cards such as a LAN card, SCSI card, USB card, and other cards that comply with PCI specifications.

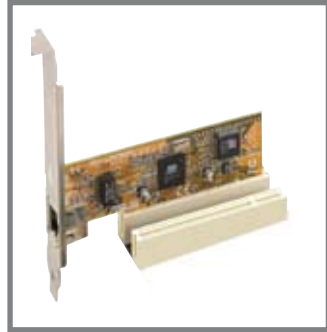

### 1.8.4 PCI Express x1 slot

This motherboard supports PCI Express x1 network cards, SCSI cards and other cards that comply with the PCI Express specifications. The figure shows a network card installed on the PCI Express x1 slot.



### 1.8.5 PCI Express x16 slot

This motherboard supports PCI Express x16 graphic cards that comply with the PCI Express specifications. The following figure shows a graphics card installed on the PCI Express x16 slot.



## 1.9 Jumpers

### 1. Clear RTC RAM (CLRRTC)

This jumper allows you to clear the Real Time Clock (RTC) RAM in CMOS. You can clear the CMOS memory of date, time, and system setup parameters by erasing the CMOS RTC RAM data. The RAM data in CMOS, that include system setup information such as system words, is powered by the onboard button cell battery.

To erase the RTC RAM:

1. Turn OFF the computer and unplug the power cord.
2. Move the jumper cap from pins 1-2 (default) to pins 2-3. Keep the cap on pins 2-3 for about 5~10 seconds, then move the cap back to pins 1-2.
3. Plug the power cord and turn ON the computer.
4. Hold down the <Del> key during the boot process and enter BIOS setup to re-enter data.



Except when clearing the RTC RAM, never remove the cap on the jumper default position. Removing the cap will cause system boot failure!

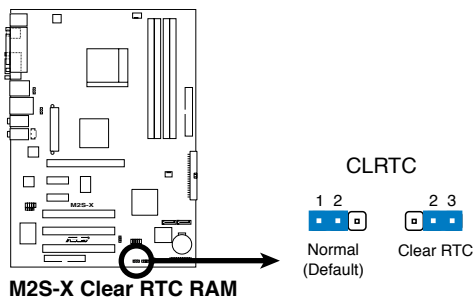

You do not need to clear the RTC when the system hangs due to overclocking. For system failure due to overclocking, use the C.P.R. (CPU Parameter Recall) feature. Shut down and reboot the system so BIOS can automatically reset parameter settings to its previous values.

## 2. USB device wake-up (3-pin USBPW12, USBPW34, USBPW56)

Set these jumpers to +5V to wake up the computer from S1 sleep mode (CPU stopped, DRAM refreshed, system running in low power mode) using the connected USB devices. Set to +5VSB to wake up from S3 and S4 sleep modes (no power to CPU, DRAM in slow refresh, power supply in reduced power mode).

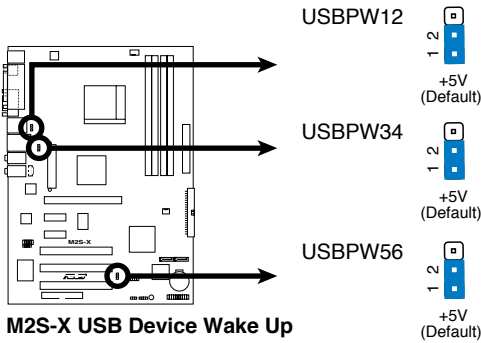

- The USB device wake-up feature requires a power supply that can provide 500mA on the +5VSB lead for each USB port. Otherwise, the system would not power up.
- The total current consumed must NOT exceed the power supply capability (+5VSB) whether under normal condition or in sleep mode.



## 1.10 Connectors

This section describes and illustrates the motherboard rear panel and internal connectors.

### 1.10.1 Rear panel connectors

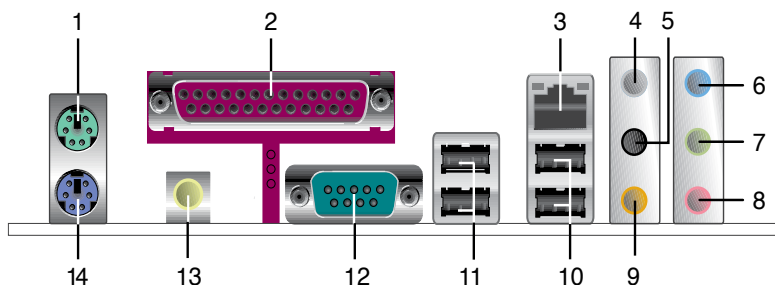

1. **PS/2 mouse port.** This green 6-pin connector is for a PS/2 mouse.
2. **Parallel port.** This 25-pin port connects a parallel printer, a scanner, or other devices.
3. **LAN (RJ-45) port.** This port allows connection to a Local Area Network (LAN) through a network hub. Refer to the table below for the LAN port LED indications.

#### LAN port LED indications

SPEED LED	
Status	Description
GREEN(Right)	10 Mbps connection
YELLOW(Left)	100 Mbps connection

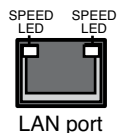

4. **Side Speaker Out port (gray).** This port connects the side speakers in an 8-channel audio configuration.
5. **Rear Speaker Out port (black).** This port connects the rear speakers in a 4-channel, 6-channel, or 8-channel audio configuration.
6. **Line In port (light blue).** This port connects the tape, CD, DVD player, or other audio sources.

7. **Line Out port (lime).** This port connects a headphone or a speaker. In 4-channel, 6-channel, and 8-channel configuration, the function of this port becomes Front Speaker Out.
8. **Microphone port (pink).** This port connects a microphone.
9. **Center/Subwoofer port (orange).** This port connects the center/subwoofer speakers.



Refer to the audio configuration table below for the function of the audio ports in 2, 4, 6, or 8-channel configuration.

## Audio 2, 4, 6, or 8-channel configuration

Port	Headset 2-channel	4-channel	6-channel	8-channel
Light Blue	Line In	Line In	Line In	Line In
Lime	Line Out	Front Speaker Out	Front Speaker Out	Front Speaker Out
Pink	Mic In	Mic In	Mic In	Mic In
Gray	–	–	–	Side Speaker Out
Black	–	Rear Speaker Out	Rear Speaker Out	Rear Speaker Out
Orange	–	–	Center/Subwoofer	Center/Subwoofer

10. **USB 2.0 ports 3 and 4.** These two 4-pin Universal Serial Bus (USB) ports are available for connecting USB 2.0 devices.
11. **USB 2.0 ports 1 and 2.** These two 4-pin Universal Serial Bus (USB) ports are available for connecting USB 2.0 devices.
12. **Serial port (COM port).** This 9-pin COM port is for pointing devices and other serial devices.
13. **Coaxial S/PDIF Out port.** This port connects an external audio output device via a coaxial S/PDIF cable.
14. **PS/2 keyboard port.** This purple connector is for a PS/2 keyboard.

## 1.10.2 Internal connectors

### 1. IDE connectors (40-1 pin PRI\_IDE, SEC\_IDE)

The onboard IDE connectors are for Ultra DMA 133/100/66 signal cable(s). There are three connectors on each Ultra DMA 133/100/66 signal cable: blue, black, and gray. Connect the blue connector to the motherboard's IDE connector, then select one of the following modes to configure your device(s).

	Drive jumper setting	Mode of device(s)	Cable connector
Single device	Cable-Select or Master	-	Black
Two devices	Cable-Select	Master Slave	Black Gray
	Master Slave	Master Slave	Black or gray



- Pin 20 on the IDE connector is removed to match the covered hole on the Ultra DMA cable connector. This prevents incorrect insertion when you connect the IDE cable.
- Use the 80-conductor IDE cable for Ultra DMA 133/100/66 IDE devices.



If any device jumper is set as "Cable-Select," make sure all other device jumpers have the same setting.

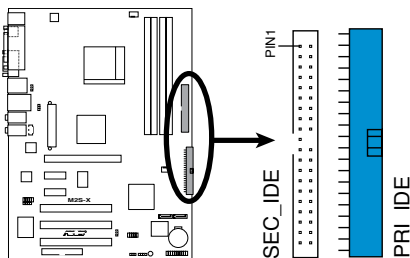

**M2S-X IDE Connectors**

## 2. Floppy disk drive connector (34-1 pin FLOPPY)

This connector supports the provided floppy drive ribbon cable. After connecting one end to the motherboard, connect the other end to the floppy drive. (Pin 5 is removed to prevent incorrect insertion when using ribbon cables with pin 5 plug).

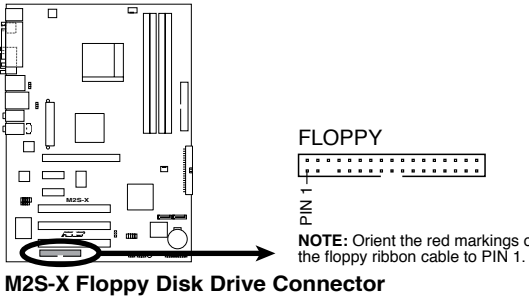

## 3. Internal audio connectors (4-pin CD)

These connectors allow you to receive stereo audio input from sound sources such as a CD-ROM, TV tuner, or MPEG card.

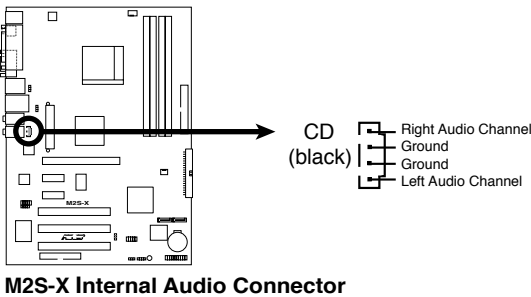

#### 4. ATX power connectors (24-pin EATXPWR, 4-pin ATX12V)

These connectors are for an ATX power supply plugs. The power supply plugs are designed to fit these connectors in only one orientation. Find the proper orientation and push down firmly until the connectors completely fit.



- Use of an ATX 12 V Specification 2.0-compliant power supply unit (PSU) that provides a minimum power of 350 W is recommended for a fully-configured system.
- Do not forget to connect the 4-pin ATX +12 V power plug; otherwise, the system will not boot up.
- Use of a power supply unit (PSU) with a higher power output is recommended when configuring a system with more power-consuming devices. The system may become unstable or may not boot up if the power is inadequate.
- Make sure that your PSU can provide at least the minimum power required by your system.

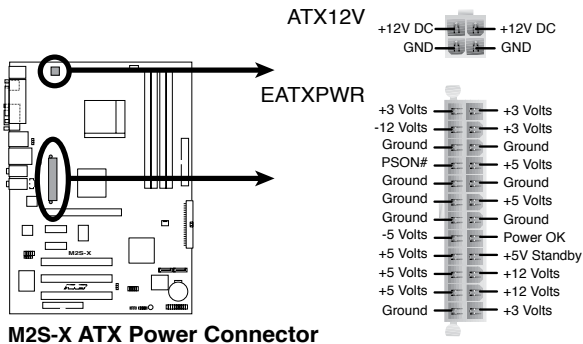

## 5. CPU and chassis fan connectors (3-pin CPU\_FAN, CHA\_FAN)

The fan connectors support cooling fans of 350mA~740mA (8.88W max.) or a total of 1A~2.22A (26.64W max.) at +12V. Connect the fan cables to the fan connectors on the motherboard, making sure that the black wire of each cable matches the ground pin of the connector.



Do not forget to connect the fan cables to the fan connectors. Lack of sufficient air flow within the system may damage the motherboard components. These are not jumpers! DO NOT place jumper caps on the fan connectors!

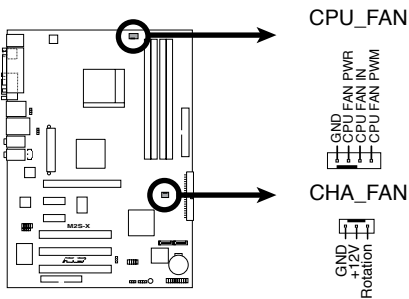

**M2S-X Fan Connectors**

## 6. USB header (10-1 pin USB56)

If the USB ports on the rear panel are inadequate, a USB header is available for additional USB ports. Connect the USB cable of the USB 2.0 module to this header. You may install the USB module in the chassis front panel. The module has two USB 2.0 ports for connecting next generation USB peripherals such as high resolution cameras, scanners, and printers.

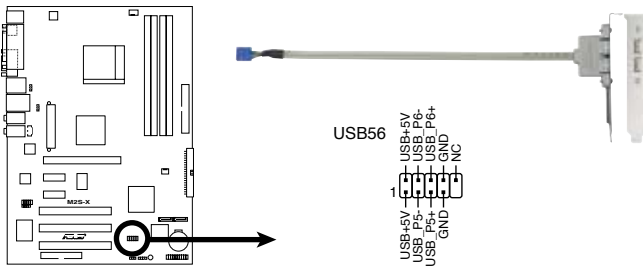

**M2S-X USB 2.0 Connectors**



The USB module is purchased separately.

## 7. Chassis intrusion connector (4-1 pin CHASSIS)

This lead is for a chassis designed with intrusion detection feature. This requires an external detection mechanism such as a chassis intrusion sensor or microswitch. When you remove any chassis component, the sensor triggers and sends a high-level signal to this lead to record a chassis intrusion event.

By default, the pins labeled “Chassis Signal” and “Ground” are shorted with a jumper cap. If you wish to use the chassis intrusion detection feature, remove the jumper cap from the pins.

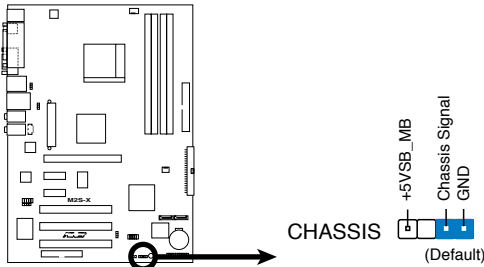

**M2S-X Chassis Intrusion Connector**

## 8. Serial ATA connectors (7-pin SATA1, SATA2)

These next generation connectors support the thin Serial ATA cables for primary internal storage devices. The current Serial ATA interface allows up to 150 MB/s data transfer rate, faster than the standard parallel ATA with 133MB/s (Ultra ATA/133).

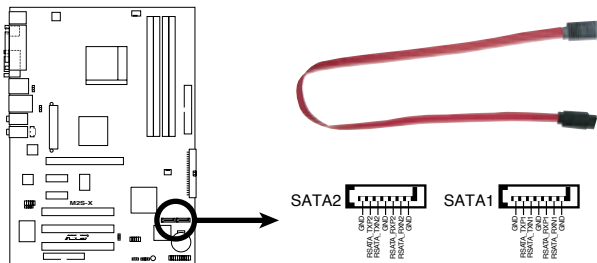

**M2S-X SATA Connectors**

**9. Front panel audio connector (10-1 pin FP\_AUDIO)**

This connector is for a chassis-mounted front panel audio I/O module that supports legacy AC '97 audio standard. Connect one end of the front panel audio I/O module cable to this connector.

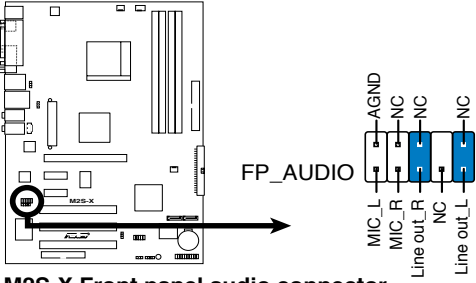

**M2S-X Front panel audio connector**

**10. System panel connector (10-1 pin PANEL)**

This connector accommodates several system front panel functions.

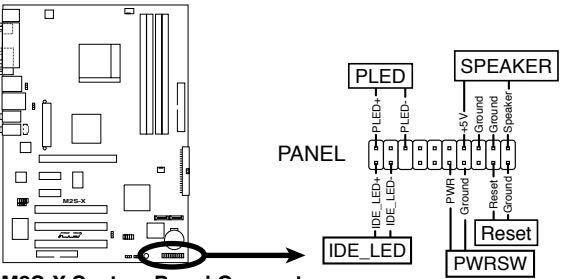

**M2S-X System Panel Connector**



- **System Power LED Lead (3-pin PLED)**

This 3-pin connector connects to the system power LED. The LED lights up when you turn on the system power, and blinks when the system is in sleep mode.

- **System Warning Speaker Lead (4-pin SPEAKER)**

This 4-pin connector connects to the case-mounted speaker and allows you to hear system beeps and warnings.

- **Reset Switch Lead (2-pin RESET)**

This 2-pin connector connects to the case-mounted reset switch for rebooting the system without turning off the system power.

- **ATX Power Switch / Soft-Off Switch Lead (2-pin PWRSW )**

This connector connects a switch that controls the system power. Pressing the power switch turns the system between ON and SLEEP, or ON and SOFT OFF, depending on the BIOS or OS settings. Pressing the power switch while in the ON mode for more than 4 seconds turns the system OFF.

- **Hard disk activity LED (2-pin IDE\_LED)**

This connector supplies power to the hard disk activity LED. Any read or write activity of an IDE device cause this LED to light up.



This chapter tells how to change the system settings through the BIOS Setup menus. Detailed descriptions of the BIOS parameters are also provided.

# BIOS setup **2**

## 2.1 Managing and updating your BIOS

The following utilities allow you to manage and update the motherboard Basic Input/Output System (BIOS) setup.

1. **ASUS AFUDOS** - Updates the BIOS using a bootable floppy disk in DOS mode.
2. **ASUS EZ Flash 2** - Updates the BIOS in DOS using a floppy disk or USB flash disk.
3. **ASUS CrashFree BIOS 3** - Updates the BIOS using a bootable USB flash disk, floppy disk or the motherboard support CD when the BIOS file fails or gets corrupted.

Refer to the corresponding sections for details on these utilities.



---

Save a copy of the original motherboard BIOS file to a bootable floppy disk in case you need to restore the BIOS in the future. Copy the original motherboard BIOS using the ASUS Update or AFUDOS utilities.

---

### 2.1.1 Creating a bootable floppy disk

1. Do either one of the following to create a bootable floppy disk.

#### *DOS environment*

- a. Insert a 1.44MB floppy disk into the drive.
- b. At the DOS prompt, type format **a: /s** then press <Enter>.

#### *Windows® XP environment*

- a. Insert a 1.44 MB floppy disk to the floppy disk drive.
- b. Click **Start** from the Windows® desktop, then select **My Computer**.
- c. Select the 3 1/2 Floppy Drive icon.
- d. Click **File** from the menu, then select **Format**. A **Format 3 1/2 Floppy Disk** window appears.
- e. Select **Create an MS-DOS startup disk** from the format options field, then click **Start**.

#### *Windows® 2000 environment*

To create a set of boot disks for Windows® 2000:

- a. Insert a formatted, high density 1.44 MB floppy disk into the drive.
- b. Insert the Windows® 2000 CD to the optical drive.
- c. Click **Start**, then select **Run**.

- d. From the Open field, type  
`D:\bootdisk\makeboot a:`  
assuming that D: is your optical drive.
  - e. Press <Enter>, then follow screen instructions to continue.
2. Copy the original or the latest motherboard BIOS file to the bootable floppy disk.

## 2.1.2 Using AFUDOS to update the BIOS

To update the BIOS using the AFUDOS.EXE utility:

1. Visit the ASUS website ([www.asus.com](http://www.asus.com)) to download the latest BIOS file for your motherboard. Save the BIOS file to a bootable floppy disk.



---

Write the BIOS file name on a piece of paper. You need to type the exact BIOS file name at the prompt.

---

2. Copy the AFUDOS.EXE utility from the support CD to the bootable floppy disk that contains the BIOS file.
3. Boot the system from the floppy disk.
4. At the DOS prompt, type the command line:

```
afudos /i[filename]
```

where **[filename]** means the latest (or original) BIOS file that you copied to the bootable floppy disk.

5. Press <Enter>. The succeeding screen displays the status of the update process.



---

The BIOS information on the screen is for reference only. What you see on your screen may not be exactly the same as shown.

---

```
A:\>afudos/im2s-x.rom
AMI Firmware Update Utility - Version 1.10
Copyright (C) 2002 American Megatrends, Inc. All rights reserved.

Reading file .... done
Erasing flash .... done
Writing flash .... 0x0008CC00 (9%)
```



---

**DO NOT** shutdown or reset the system while updating the BIOS! Doing so may cause system boot failure!

---

When the BIOS update process is complete, the utility returns to the DOS prompt.

```
A:\>afudos /iM2S-X.ROM
AMI Firmware Update Utility - Version 1.10
Copyright (C) 2002 American Megatrends, Inc. All rights reserved.

Reading file .... done
Erasing flash ... done
Writing flash ... done
Verifying flash .. done

A:\>
```

5. Reboot the system from the hard disk.

### 2.1.3 Using AFUDOS to copy BIOS from PC

You can use the AFUDOS.EXE utility to copy the current system BIOS to a floppy or hard disk and use it as a backup in case the system BIOS fails or gets corrupted.

To copy the BIOS from your PC using **AFUDOS.EXE**:

1. At the DOS prompt, type the command line:

```
afudos /o[filename]
```

where [filename] string of not more than eight (8) alpha-numeric characters for the main filename and three (3) alpha-numeric characters for the extension name.

2. Press <Enter>.



The BIOS information on the screen is for reference only. What you see on your screen may not be exactly the same as shown.

```

Main filename
Extension name
A:\>afudos /oMYEIOS03.rom
AMI Firmware Update Utility - Version 1.10
Copyright (C) 2002 American Megatrends, Inc. All rights reserved.

Reading flash .... 0x0008CC00 (9%)
```

3. The utility will copy the current system BIOS by default to the floppy disk. Make sure that the floppy disk has at least 600KB of free disk space and is not write-protected.

```
A:\>afudos /oMYBIOS03.ROM
AMI Firmware Update Utility - Version 1.10
Copyright (C) 2002 American Megatrends, Inc. All rights reserved.

Reading flash . . . . done

A:\>
```

When the copy process is complete, the utility returns to the DOS prompt.

### 2.1.4 Using ASUS EZ Flash 2 to update the BIOS

The ASUS EZ Flash 2 feature allows you to easily update the BIOS without having to go through the long process of booting from a diskette and using a DOS-based utility. The EZ Flash 2 is built-in the BIOS firmware so it is accessible by simply pressing <Alt + F2> during the Power-On Self Tests (POST).

#### To update the BIOS using ASUS EZ Flash 2:

1. Go to the ASUS website ([www.asus.com](http://www.asus.com)) and download the latest BIOS file for your motherboard.
2. Save the BIOS file to a floppy disk or a USB flash disk then restart your computer.
3. You can launch the EZ Flash 2 in two ways:  
(1) Insert the floppy disk or USB flash disk that contains the BIOS file into the floppy disk drive or the USB port.

Press <Alt> + <F2> during POST to display the following.

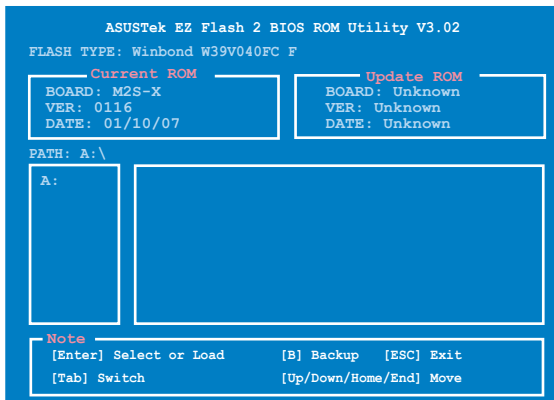

(2) Enter BIOS setup program. Go to the Tools menu then select EZ Flash 2 and press <Enter>.

You can switch between drives by pressing <Tab> before the correct file is found. Then press <Enter>.

4. When the correct BIOS file is found, EZ Flash 2 performs the BIOS update process and automatically reboots the system when done.



- This function can support devices such as USB flash disk, hard disk, or floppy disk with FAT 32/16/12 format only.
- Do not shut down or reset the system while updating the BIOS to prevent system boot failure!

### 2.1.5 Recovering the BIOS with CrashFree BIOS 3

The ASUS CrashFree BIOS 3 is an auto recovery tool that allows you to restore the BIOS file when it fails or gets corrupted during the updating process. You can update a corrupted BIOS file using the motherboard support CD, floppy, or USB flash disk that contains the updated BIOS file.



Prepare the support CD that came with the motherboard or a floppy disk that contains the motherboard BIOS before proceeding with the BIOS update process.

### Recovering the BIOS from the support CD

To recover the BIOS from the support CD:

1. Turn on the system.
2. Insert the motherboard support CD to the optical drive.
3. The utility displays the following message and automatically checks the CD for the BIOS file.

```
Bad BIOS checksum. Starting BIOS recovery...  
Checking for floppy...
```



When found, the utility reads the BIOS file and starts flashing the corrupted BIOS file.

```
Bad BIOS checksum. Starting BIOS recovery...
Checking for floppy...
Floppy not found!
Checking for CD-ROM...
CD-ROM found!
Reading file "M2S-X.ROM". Completed.
Start flashing...
```

4. Restart the system after the utility completes the updating process.

## Recovering the BIOS from the USB flash disk

To recover the BIOS from the USB flash disk:

1. Insert the USB flash disk that contains BIOS file to the USB port.
2. Turn on the system.
3. The utility will automatically checks the devices for the BIOS file When found, the utility reads the BIOS file and starts flashing the corrupted BIOS file.
4. Restart the system after the utility completes the updating process.



- 
- Use only a USB flash disk smaller than 8GB with single partition and FAT 32/16/12 format.
  - DO NOT shut down or reset the system while updating the BIOS! Doing so can cause system boot failure!
-

## Recovering the BIOS from a floppy disk

To recover the BIOS from a floppy disk:

1. Turn on the system.
2. Insert the floppy disk with the original or updated BIOS file to the floppy disk drive.
3. The utility displays the following message and automatically checks the floppy disk for the original or updated BIOS file.

```
Bad BIOS checksum. Starting BIOS recovery...  
Checking for floppy...
```

When found, the utility reads the BIOS file and starts flashing the corrupted BIOS file.

```
Bad BIOS checksum. Starting BIOS recovery...  
Checking for floppy...  
Floppy found!  
Reading file "P5RD2VM.ROM". Completed.  
Start flashing...
```



---

DO NOT shut down or reset the system while updating the BIOS! Doing so can cause system boot failure!

---

4. Restart the system after the utility completes the updating process.



---

The recovered BIOS may not be the latest BIOS version for this motherboard. Visit the ASUS website ([www.asus.com](http://www.asus.com)) to download the latest BIOS file.

---

## 2.2 BIOS Setup program

This motherboard supports a programmable LPC chip that you can update using the provided utility described in section “2.1 Managing and updating your BIOS.”

Use the BIOS Setup program when you are installing a motherboard, reconfiguring your system, or prompted to “Run Setup”. This section explains how to configure your system using this utility.

Even if you are not prompted to use the Setup program, you may want to change the configuration of your computer in the future. For example, you may want to enable the security password feature or change the power management settings. This requires you to reconfigure your system using the BIOS Setup program so that the computer can recognize these changes and record them in the CMOS RAM of the LPC.

The LPC on the motherboard stores the Setup utility. When you start up the computer, the system provides you with the opportunity to run this program. Press <Del> during the Power-On Self Test (POST) to enter the Setup utility. Otherwise, POST continues with its test routines.

If you wish to enter Setup after POST, restart the system by pressing <Ctrl>+<Alt>+<Del>, or by pressing the reset button on the system chassis. You can also restart by turning the system off and then back on. Do this last option only if the first two failed.

The Setup program is designed to make it as easy to use as possible. It is a menu-driven program, which means you can scroll through the various sub-menus and make your selections from the available options using the navigation keys.



---

The default BIOS settings for this motherboard apply for most conditions to ensure optimum performance. If the system becomes unstable after changing any BIOS settings, load the default settings to ensure system compatibility and stability. Select the **Load Default Settings** item under the Exit Menu. See section “2.8 Exit Menu.”

---



---

The BIOS setup screens shown in this chapter are for reference purposes only, and may not exactly match what you see on your screen.

Visit the ASUS website ([www.asus.com](http://www.asus.com)) to download the latest product and BIOS information.

---

## 2.2.1 BIOS menu screen

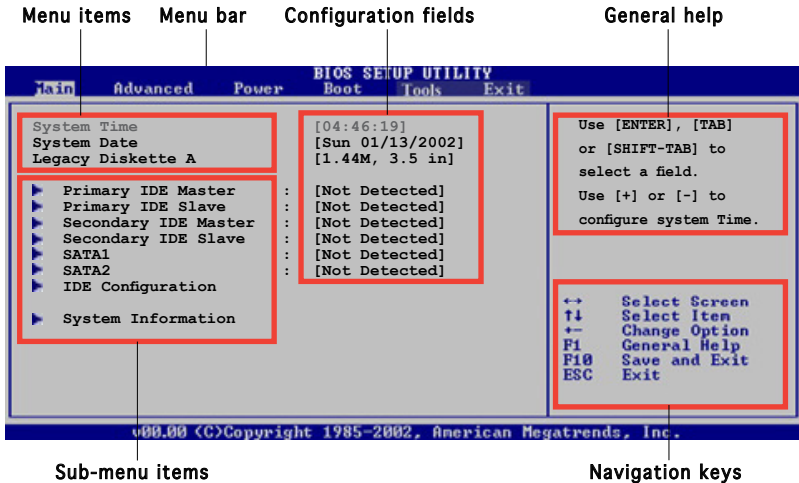

## 2.2.2 Menu bar

The menu bar on top of the screen has the following main items:

- Main** For changing the basic system configuration
- Advanced** For changing the advanced system settings
- Power** For changing the advanced power management (APM) configuration
- Boot** For changing the system boot configuration
- Tools** For setting EZ Flash 2.
- Exit** For selecting the exit options and loading default settings

To select an item on the menu bar, press the right or left arrow key on the keyboard until the desired item is highlighted.

## 2.2.3 Navigation keys

At the bottom right corner of a menu screen are the navigation keys for that particular menu. Use the navigation keys to select items in the menu and change the settings.



---

Some of the navigation keys differ from one screen to another.

---

## 2.2.4 Menu items

The highlighted item on the menu bar displays the specific items for that menu. For example, selecting **Main** shows the Main menu items.

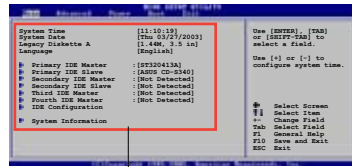

Main menu items

## 2.2.5 Sub-menu items

An item with a sub-menu on any menu screen is distinguished by a solid triangle before the item. To display the sub-menu, select the item and press <Enter>.

## 2.2.6 Configuration fields

These fields show the values for the menu items. If an item is user-configurable, you may change the value of the field opposite the item. You can not select an item that is not user-configurable.

A configurable field is enclosed in brackets, and is highlighted when selected. To change the value of a field, select it then press <Enter> to display a list of options. Refer to “2.2.7 Pop-up window.”

## 2.2.7 Pop-up window

Select a menu item then press Enter to display a pop-up window with the configuration options for that item.

## 2.2.8 Scroll bar

A scroll bar appears on the right side of a menu screen when there are items that do not fit on the screen. Press **Up/Down arrow keys** or **PageUp/PageDown keys** to display the other items on the screen.

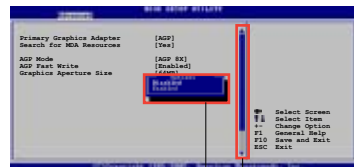

Pop-up window

Scroll bar

## 2.2.9 General help

At the top right corner of the menu screen is a brief description of the selected item.

## 2.3 Main menu

When you enter the BIOS Setup program, the Main menu screen appears giving you an overview of the basic system information.



Refer to section “2.2.1 BIOS menu screen” for information on the menu screen items and how to navigate through them.

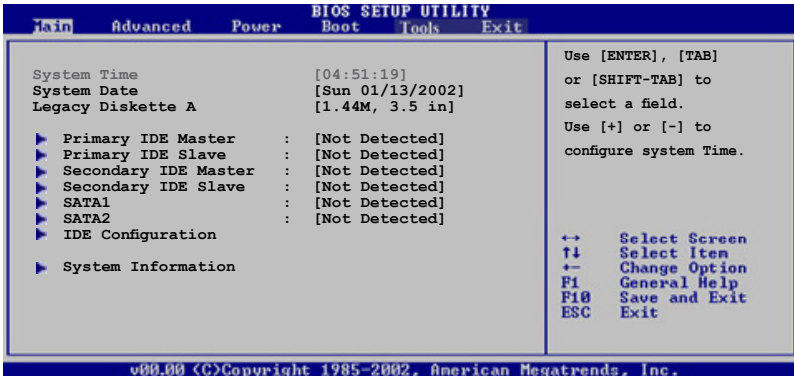

### 2.3.1 System Time [xx:xx:xxxx]

Allows you to set the system time.

### 2.3.2 System Date [Day xx/xx/xxxx]

Allows you to set the system date.

### 2.3.3 Legacy Diskette A [1.44M, 3.5 in.]

Sets the type of floppy drive installed.

Configuration options: [Disabled] [360K, 5.25 in.] [1.2M , 5.25 in.] [720K , 3.5 in.] [1.44M, 3.5 in.] [2.88M, 3.5 in.]

## 2.3.4 Primary and Secondary IDE Master/Slave

While entering Setup, BIOS auto-detects the presence of IDE devices. There is a separate sub-menu for each IDE device. Select a device item then press <Enter> to display the IDE device information.

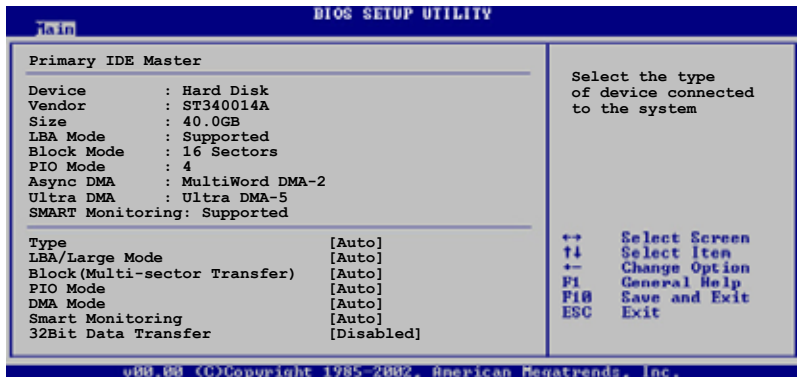

The values opposite the dimmed items (Device, Vendor, Size, LBA Mode, Block Mode, PIO Mode, Async DMA, Ultra DMA, and SMART monitoring) are auto-detected by BIOS and are not user-configurable. These items show N/A if no IDE device is installed in the system.

### Type [Auto]

Selects the type of IDE drive. Setting to Auto allows automatic selection of the appropriate IDE device type. Select CDRM if you are specifically configuring a CD-ROM drive. Select ARMD (ATAPI Removable Media Device) if your device is either a ZIP, LS-120, or MO drive. Configuration options: [Not Installed] [Auto] [CDROM] [ARMD]

### LBA/Large Mode [Auto]

Enables or disables the LBA mode. Setting to Auto enables the LBA mode if the device supports this mode, and if the device was not previously formatted with LBA mode disabled. Configuration options: [Disabled] [Auto]

### Block (Multi-sector Transfer) [Auto]

Enables or disables data multi-sectors transfers. When set to Auto, the data transfer from and to the device occurs multiple sectors at a time if the device supports multi-sector transfer feature. When set to Disabled, the data transfer from and to the device occurs one sector at a time. Configuration options: [Disabled] [Auto]

### PIO Mode [Auto]

Selects the PIO mode. Configuration options: [Auto] [0] [1] [2] [3] [4]

### DMA Mode [Auto]

Selects the DMA mode. Configuration options: [Auto] [SWDMA0] [SWDMA1] [SWDMA2] [MWDMA0] [MWDMA1] [MWDMA2] [UDMA0] [UDMA1] [UDMA2] [UDMA3] [UDMA4] [UDMA5]

### SMART Monitoring [Auto]

Sets the Smart Monitoring, Analysis, and Reporting Technology.  
Configuration options: [Auto] [Disabled] [Enabled]

### 32Bit Data Transfer [Disabled]

Enables or disables 32-bit data transfer.  
Configuration options: [Disabled] [Enabled]

## 2.3.5 SATA1 and SATA2

While entering setup, the BIOS auto detects the presence of IDE devices. There is a separate sub-menu for each IDE device. Select a device item then press <Enter> to display the IDE device information.

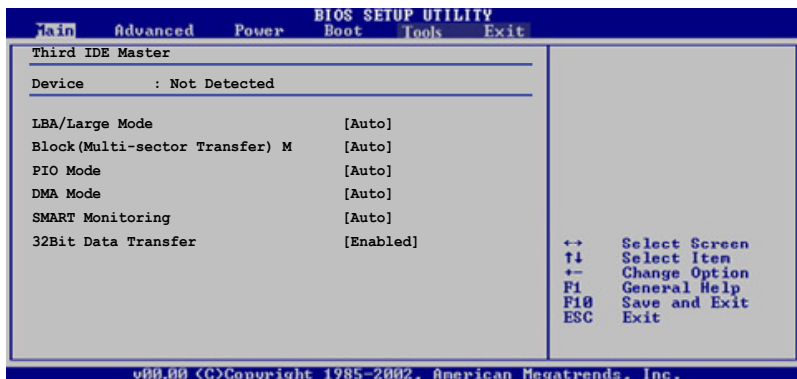



The BIOS automatically detects the values opposite the dimmed items (Device, Vendor, Size, LBA Mode, Block Mode, PIO Mode, Async DMA, Ultra DMA, and SMART monitoring). These values are not user-configurable. These items show N/A if no IDE device is installed in the system.

### **Type [Auto]**

Selects the type of IDE drive. Setting to Auto allows automatic selection of the appropriate IDE device type. Select CDROM if you are specifically configuring a CD-ROM drive. Select ARMD (ATAPI Removable Media Device) if your device is either a ZIP, LS-120, or MO drive. Configuration options: [Not Installed] [Auto] [CDROM] [ARMD]

### **LBA/Large Mode [Auto]**

Enables or disables the LBA mode. Setting to Auto enables the LBA mode if the device supports this mode, and if the device was not previously formatted with LBA mode disabled. Configuration options: [Disabled] [Auto]

### **Block (Multi-sector Transfer) M [Auto]**

Enables or disables data multi-sectors transfers. When set to Auto, the data transfer from and to the device occurs multiple sectors at a time if the device supports multi-sector transfer feature. When set to [Disabled], the data transfer from and to the device occurs one sector at a time. Configuration options: [Disabled] [Auto]

### **PIO Mode [Auto]**

Selects the PIO mode.  
Configuration options: [Auto] [0] [1] [2] [3] [4]

### **DMA Mode [Auto]**

Selects the DMA mode. Configuration options: [Auto] [SWDMA0] [SWDMA1] [SWDMA2] [MWDMA0] [MWDMA1] [MWDMA2] [UDMA0] [UDMA1] [UDMA2] [UDMA3] [UDMA4] [UDMA5]

### **SMART Monitoring [Auto]**

Sets the Smart Monitoring, Analysis, and Reporting Technology.  
Configuration options: [Auto] [Disabled] [Enabled]

### **32Bit Data Transfer [Disabled]**

Enables or disables 32-bit data transfer.  
Configuration options: [Disabled] [Enabled]

## 2.3.6 IDE Configuration

The items in this menu allow you to set or change the configurations for the IDE devices installed in the system. Select an item then press <Enter> if you wish to configure the item.

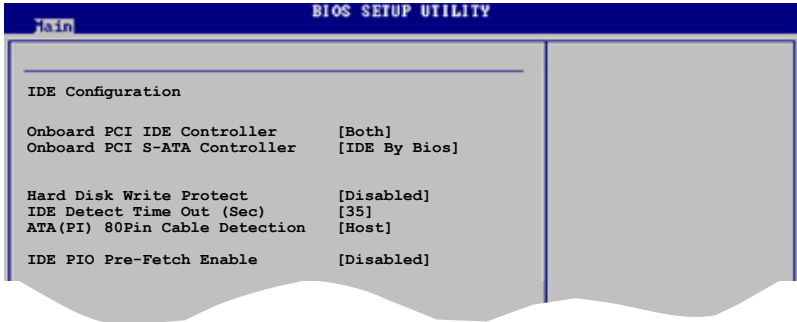

### Onboard PCI IDE Controller [Both]

Allows you to set the onboard PCI IDE Controller. Set to [Disabled] to disable the integrated IDE Controller. Set to [Primary] to enable only the Primary IDE Controller. Set to [Secondary] to enable only the Secondary IDE Controller. Set to [Both] to enable both IDE Controller.  
Configuration options: [Disabled] [Primary] [Secondary] [Both]

### Onboard PCI S-ATA Controller [IDE By Bios]

Allows you to set the onboard PCI S-ATA Controller.  
Configuration options: [Disabled] [IDE By Bios] [RAID By Rom]

### Hard Disk Write Protect [Disabled]

Allows you to enable or disable device write protection. This will be effective only if the device is accessed through BIOS.  
Configuration options: [Disabled] [Enabled]

### IDE Detect Time Out [35]

Selects the time out value for detecting ATA/ATAPI devices.  
Configuration options: [0] [5] [10] [15] [20] [25] [30] [35]

### ATA(PI) 80Pin Cable Detection [Host]

Selects the mechanism for detecting 80Pin ATA(PI) Cable.  
Configuration options: [Host & Device] [Host] [Device]

### IDE PIO Pre-Fetch Enable [Disabled]

Allows you to enable or disable IDE PIO Pre-fetch Enable. Set it to [Disabled] before testing AMIDIAG.  
Configuration options: [Disabled] [Enabled]

## 2.3.7 System Information

This menu gives you an overview of the general system specifications. The items in this menu are auto-detected by BIOS.



### AMIBIOS

Displays the auto-detected BIOS information.

### Processor

Displays the auto-detected processor information.

### System Memory

Displays the auto-detected system memory.

## 2.4 Advanced menu

The Advanced menu items allow you to change the settings for the CPU and other system devices.



Take caution when changing the settings of the Advanced menu items. Incorrect field values may cause the system to malfunction.

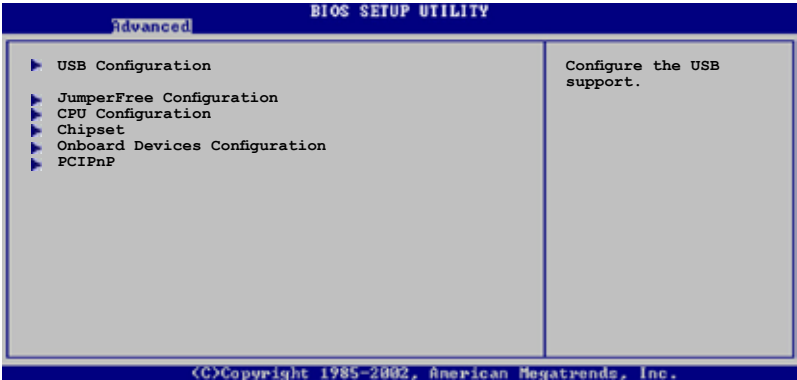

### 2.4.1 USB Configuration

The items in this menu allows you to change the USB-related features. Select an item then press <Enter> to display the configuration options.

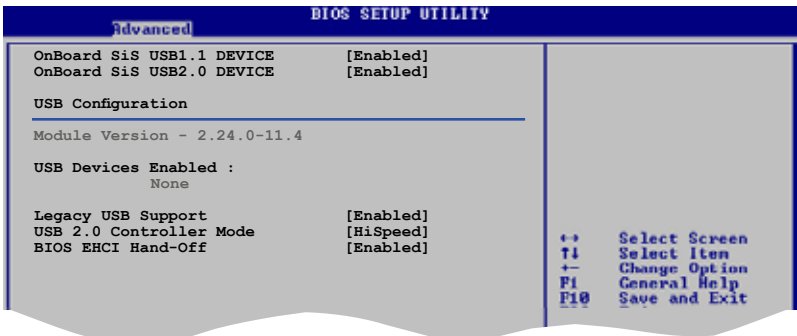

#### OnBoard SiS USB1.1 DEVICE [Enabled]

Allows you to enable or disable the onboard SiS USB 1.1 port. Configuration options: [Disabled] [Enabled]

#### OnBoard SiS USB2.0 DEVICE [Enabled]

Allows you to enable or disable the onboard SiS USB 2.0 port. Configuration options: [Disabled] [Enabled]



The Module Version and USB Devices Enabled items show the auto-detected values. If no USB device is detected, the item shows None.

## Legacy USB Support [Enabled]

Allows you to enable or disable the legacy USB support. When set to Auto, the system disables the legacy USB support if there are no USB devices connected. Configuration options: [Disabled] [Enabled] [Auto]

## USB 2.0 Controller Mode [HiSpeed]

Allows you to configure the USB 2.0 controller in HiSpeed (480 Mbps) or Full Speed (12 Mbps). Configuration options: [HiSpeed ] [Full Speed]

## BIOS EHCI Hand-Off [Enabled]

Allows you to stop the EHCI HC in OHCI handover. Enable this item when installing operating systems that does not support EHCI host controllers. Configuration options: [Disabled] [Enabled]

## 2.4.2 JumperFree Configuration



## AI Overclocking [Auto]

Select the target CPU frequency, and the relevant parameters will be auto-adjusted. Frequencies higher than CPU manufacture recommends are not guaranteed to be stable. If the system becomes unstable, return to the default. Configuration options: [Manual] [Auto] [Overclock Profile]

### 2.4.3 CPU Configuration

The CPU configuration menu displays the current CPU configuration.



The items in this menu varies depending on the type of processor installed.

#### Cool N' Quiet [Enabled]

Allows you to enable or disable the AMD Cool 'n' Quiet!™ Technology feature. Configuration options: [Enabled] [Disabled]



Make sure that the above item is set to **Enabled** if you want to use the AMD CPU Cool 'n' Quiet!™ Technology feature.

### 2.4.4 Chipset

The Chipset menu items allow you to change the advanced chipset settings. Select an item then press <Enter> to display the sub-menu.

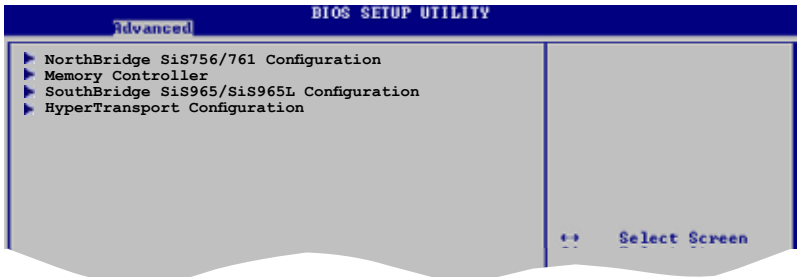

# NorthBridge SiS756/761 Configuration

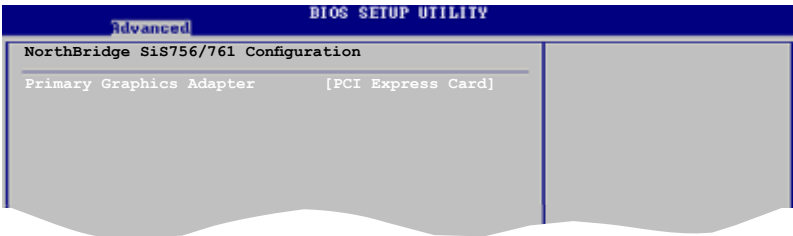

## Primary Graphics Adapter [PCI Express Card]

Sets the primary graphics adapter. Configuration options: [PCI Express Card] [PCI]

## Memory Controller

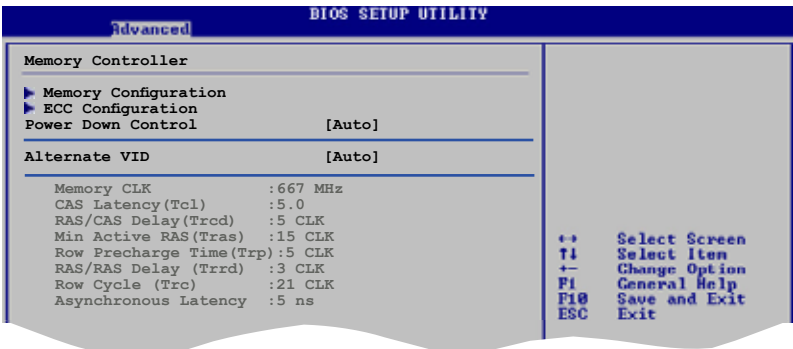

## Memory Configuration

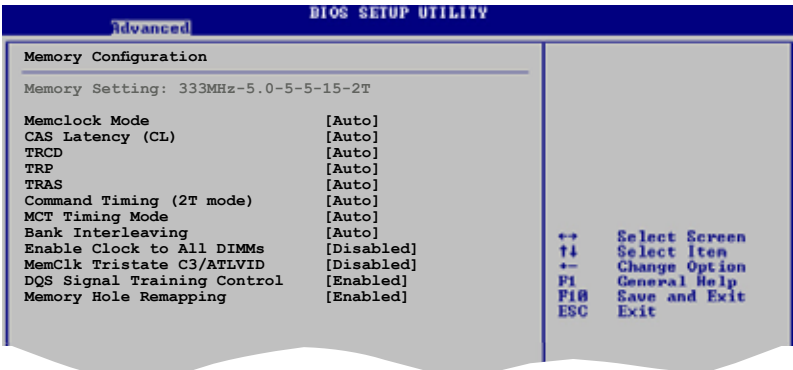

## Memclock Mode [ Auto ]

Allows you to set the memory clock mode. Set by the code using [Auto] or select [Limit] to set using one of the standard values.

Configuration options: [Auto] [Limit] [Manual]



---

The following items appear when the Memclock Mode is set to [Limit] or [Manual].

---

### Memclock Value [400MHz]

This item sets the Memclock value.

Configuration options: [400MHz] [533MHz] [667MHz] [800MHz]

## CAS Latency (CL) [Auto]

Sets the CAS Latency. Configuration options: [Auto] [3.0] [4.0] [5.0] [6.0]

## TRCD [Auto]

Sets the TRCD. Configuration options: [Auto] [3 CLK] [4 CLK] [5 CLK] [6 CLK]

## TRP [Auto]

Sets the TRP. Configuration options: [Auto] [3 CLK] [4 CLK] [5 CLK] [6 CLK]

## TRAS [Auto]

This item sets the TRAS. Configuration options: [Auto] [5 CLK] [6 CLK] [7 CLK] [8 CLK] [9 CLK] [10 CLK] [11 CLK] [12 CLK] [13 CLK] [14 CLK] [15 CLK] [16 CLK] [17 CLK] [18 CLK]

## Command Timing (2T mode) [Auto]

Sets the Command Timing. Configuration options: [Auto] [1T] [2T]

## MCT Timing Mode [Auto]

Allows you to set the MCT timing mode. Set by the code using [Auto] or select [Manual] to set using one of the standard values. Configuration options: [Auto] [Manual]



---

The following items appear only when the MCT Timing Mode is set to [Manual].

---



### TRRD [Auto]

Sets the TRRD. Configuration options: [Auto] [2T] [3T] [4T] [5T]

### TRC [Auto]

Sets the TRC.

Configuration options: [Auto] [11T] [12T] [13T] [14T] [15T] [16T] [17T] [18T] [19T] [20T] [21T] [22T] [23T] [24T] [25T] [26T]

## **Bank Interleaving[Auto]**

Allows you to set the Bank Interleaving. Configuration options: [Disabled] [Auto]

## **Enable Clock to All DIMMs [Disabled]**

Allows you to enable unused clocks to DIMMs even memory slots are not populated. Configuration options: [Disabled] [Enabled]

## **MemClk Tristate C3/ATLVID [Disabled]**

Enables or disables the MemClk Tri-Stating during C3 and Alt VID. Configuration options: [Disabled] [Enabled]

## **DQS Signal Training Control [Enabled]**

Enables or disables the DQS Signal Training Control. Turning this off will require custom memory timings programming. Training will be automatically disabled if CS Sparing is enabled. Configuration options: [Disabled] [Enabled]

## **Memory Hole Remapping [Enabled]**

Enables or disables the software memory remapping around the memory hole. Configuration options: [Disabled] [Enabled]

## **Power Down Control [Auto]**

Allows DIMMs to enter power down mode by deasserting the clock enable signal when DIMMs are not in use. Configuration options: [Auto] [Disabled]

## **Alternate VID [Auto]**

Allows you to specify the alternate VID while in low power states.

Configuration options: [1.550V] [1.525V] [1.500V] [1.475V] [1.450V] [1.425V] [1.400V] [1.375V] [1.350V] [1.325V] [1.300V] [1.275V] [1.250V] [1.225V] [1.200V] [1.175V] [1.150V] [1.125V] [1.100V] [1.075V] [1.050V] [1.025V] [1.000V] [0.975V] [0.950V] [0.925V] [0.900V] [0.875V] [0.850V] [0.825V] [0.800V] [Auto]

# ECC Configuration

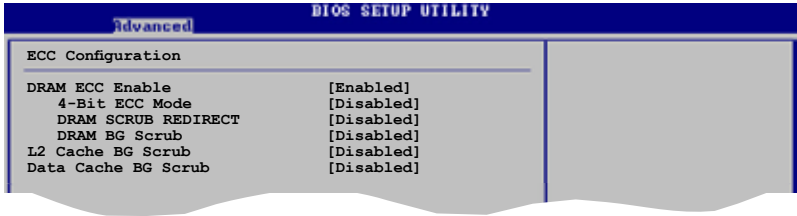

## DRAM ECC Enable [Disabled]

Enables or disables the DRAM ECC that allows hardware to report and correct memory errors automatically to maintain system integrity. Configuration options: [Disabled] [Enabled]



The following item appears only when the **DRAM ECC** item is set to [Enabled].

### 4-Bit ECC Mode [Disabled]

Enables or disables the 4-Bit ECC mode. Configuration options: [Disabled] [Enabled]

### DRAM SCRUB REDIRECT [Disabled]

Sets the system to correct DRAM ECC Errors immediately when they occur, even if background scrubbing is on. Configuration options: [Disabled] [Enabled]

### DRAM BG Scrub [Disabled]

Disables or sets the DRAM scrubbing functionality that corrects and rewrites memory errors so later reads are correct. During this while the memory is not being used improves performance. Configuration options: [Disabled] [40ns] [80ns] [160ns] [320ns] [640ns] [1.28us] [2.56us] [5.12us] [10.2us] [20.5us] [41.0us] [81.9us] [163.8us] [327.7us] [655.4us]

## L2 Cache BG Scrub [Disabled]

Allows the L2 Data Cache ram to be corrected while idle. Configuration options: [Disabled] [40ns] [80ns] [160ns] [320ns] [640ns] [1.28us] [2.56us] [5.12us] [10.2us] [20.5us] [41.0us] [81.9us] [163.8us] [327.7us] [655.4us] [1.31ms] [2.62ms] [5.24ms] [10.49ms] [20.97ms] [42.00ms] [84.00ms]

## Data Cache BG Scrub [Disabled]

Allows the L1 Data Cache ram to be corrected while idle. Configuration options: [Disabled] [40ns] [80ns] [160ns] [320ns] [640ns] [1.28us] [2.56us] [5.12us] [10.2us] [20.5us] [41.0us] [81.9us] [163.8us] [327.7us] [655.4us] [1.31ms] [2.62ms] [5.24ms] [10.49ms] [20.97ms] [42.00ms] [84.00ms]

## SouthBridge SiS965/SiS965L Configuration

Advanced		BIOS SETUP UTILITY	
OnBoard SiS190 Lan DEVICE	[Enabled]		
OnBoard LAN Boot ROM	[Disabled]		

### Onboard SiS190 Lan DEVICE [Enabled]

Allows you to enable or disable the onboard SIS 190 Lan controller.  
Configuration options: [Disabled] [Enabled]

### Onboard LAN Boot ROM [Enabled]

Allows you to enable or disable the onboard LAN Boot ROM.  
Configuration options: [Disabled] [Enabled]

## HyperTransport Configuration

Advanced		BIOS SETUP UTILITY	
HyperTransport Configuration			
Method to setup HT link	[Auto]		
HT Width	[16 BIT]		
HT Speed	[800 MHz]		

### Method to setup HT link [Auto]

Allows you to setup HT link frequency/width by auto/manual. Configuration options: [Auto] [Manual]



The following items appear only when the Method to setup HT link is set to [Manual].

#### HT Width [Auto]

Allows selection of HyperTransport upstream data width.  
Configuration options: [8 BIT] [16 BIT]

#### HT Speed [800 MHz]

Sets the HyperTransport frequency from CPU to the NorthBridge.  
Configuration options: [200 Mhz] [400 Mhz] [800 Mhz]

## 2.4.5 Onboard Devices Configuration

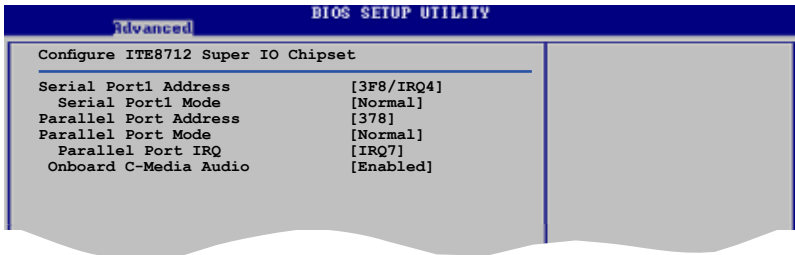

### Serial Port1 Address [3F8/IRQ4]

Allows you to select the Serial Port1 base address.

Configuration options: [Disabled] [3F8/IRQ4] [2F8/IRQ3] [3E8/IRQ4] [2E8/IRQ3]

#### Serial Port Mode [Normal]

Allows you to select the Serial Port mode.

Configuration options: [Normal] [IrDA] [ASK IR]

### Parallel Port Address [378]

Allows you to select the Parallel Port base addresses.

Configuration options: [Disabled] [378] [278] [3BC]

### Parallel Port Mode [Normal]

Allows you to select the Parallel Port mode.

Configuration options: [Normal] [EPP] [ECP] [EPP+ECP]

#### EPP Version [1.9]

Appears when the Parallel Port Mode is set to [EPP] or [EPP+ECP]. This item allows you to select the Parallel Port EPP version. Configuration options: [1.9] [1.7]

#### ECP Mode DMA Channel [DMA3]

Appears when the Parallel Port Mode is set to [ECP] or [EPP+ECP]. This item allows you to set the Parallel Port ECP DMA.

Configuration options: [DMA0] [DMA1] [DMA3]

#### Parallel Port IRQ [IRQ7]

Sets the Parallel Port IRQ. Configuration options: [IRQ5] [IRQ7]

### Onboard C-Media Audio [Enabled]

Enables or disables the onboard C-Media audio.

Configuration options: [Disabled] [Enabled]

## 2.4.6 PCI PnP

The PCI PnP menu items allow you to change the advanced settings for PCI/PnP devices. The menu includes setting IRQ and DMA channel resources for either PCI/PnP or legacy ISA devices, and setting the memory size block for legacy ISA devices.



Take caution when changing the settings of the PCI PnP menu items. Incorrect field values may cause the system to malfunction.



### Plug and Play O/S [No]

When set to [No], BIOS configures all the devices in the system. When set to [Yes] and if you installed a Plug & Play operating system, the operating system configures the Plug & Play devices not required for boot.

Configuration options: [No] [Yes]

### PCI Latency Timer [64]

Allows you to select the value in units of PCI clocks for the PCI device latency timer register. Configuration options: [32] [64] [96] [128] [160] [192] [224] [248]

### Allocate IRQ to PCI VGA [Yes]

When set to [Yes], BIOS assigns an IRQ to PCI VGA card if the card requests for an IRQ. When set to [No], BIOS does not assign an IRQ to the PCI VGA card even if requested. Configuration options: [Yes] [No]

### Palette Snooping [Disabled]

When set to [Enabled], the palette snooping feature informs the PCI devices that an ISA graphics device is installed in the system so that the latter can function correctly. Setting to [Disabled] deactivates this feature. Configuration options: [Disabled] [Enabled]

## 2.5 Power menu

The Power menu items allow you to change the settings for the Advanced Power Management (APM) feature. Select an item then press <Enter> to display the configuration options.



### 2.5.1 Suspend Mode [Auto]

Allows you to select the ACPI state to be used for system suspend.  
Configuration options: [S1 (POS) Only] [S3 Only] [Auto]

### 2.5.2 ACPI Version Features [ACPI v1.0]

Allows you to add additional tables as per ACPI 2.0 specifications.  
Configuration options: [ACPI v1.0] [ACPI v2.0] [ACPI v3.0]

### 2.5.3 ACPI APIC Support [Enabled]

Enables or disables the ACPI support in the ASIC. When set to Enabled, the ACPI APIC table pointer is included in the RSDT pointer list.  
Configuration options: [Disabled] [Enabled]

## 2.5.4 APM Configuration

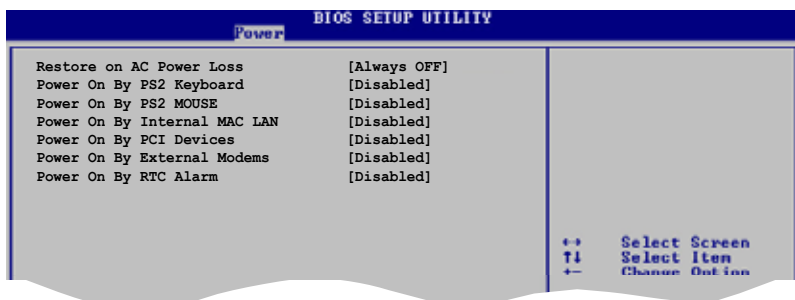

### Restore on AC/Power Loss [Always OFF]

When set to Power Off, the system goes into off state after an AC power loss. When set to Power On, the system goes on after an AC power loss. When set to Last State, the system goes into either off or on state whatever the system state before the AC power loss. Configuration options: [Always OFF] [Always On] [Keep Previous State]

### Power On By PS2 Keyboard [Disabled]

Allows you to disable or set the keyboard wake-up feature. This feature requires an ATX power supply that provides at least 1A on the +5VSB lead. Configuration options: [Disabled] [Enabled]

### Power On By PS2 Mouse [Disabled]

When set to [Enabled], this parameter allows you to use the PS/2 mouse to resume the system. This feature requires an ATX power supply that provides at least 1A on the +5VSB lead. Configuration options: [Disabled] [Enabled]

### Power On By Internal MAC LAN [Disabled]

Allows you to enable or disable the MAC wake from sleep states. Configuration options: [Disabled] [Enabled]

### Power On By PCI Devices [Disabled]

Allows you to enable or disable the PME to generate a wake event. This feature requires an ATX power supply that provides at least 1A on the +5VSB lead. Configuration options: [Disabled] [Enabled]

### Power On By External Modems [Disabled]

Allows either settings of [Enabled] or [Disabled] for powering up the computer when the external modem receives a call while the computer is in Soft-off mode. Configuration options: [Disabled] [Enabled]



The computer cannot receive or transmit data until the computer and applications are fully running. Thus, connection cannot be made on the first try. Turning an external modem off and then back on while the computer is off causes an initialization string that turns the system power on.

## Power On By RTC Alarm [Disabled]

Allows you to enable or disable RTC to generate a wake event. When this item is set to Enabled, the items RTC Alarm Date, RTC Alarm Hour, RTC Alarm Minute, and RTC Alarm Second appear with set values.

Configuration options: [Disabled] [Enabled]

## 2.5.5 Hardware Monitor

BIOS SETUP UTILITY	
Power	
Hardware Monitor	
CPU Temperature	[40.5°C/102.5°F]
MB Temperature	[33°C/91°F]
CPU Fan Speed	[3260RPM]
Chassis Fan Speed	[N/A]
Power Fan Speed	[N/A]
VCORE Voltage	[ 1.408V]
3.3V Voltage	[ 3.360V]
5V Voltage	[ 5.160V]
12V Voltage	[11.328V]
Smart Q-FAN Function	[Disabled]
CPU Temperature	
←→	Select Screen
↑↓	Select Item
+ -	Change Option
F1	General Help
F10	Save and Exit
ESC	Exit

**CPU Temperature [xxx °C/xxx °F]**

**MB Temperature [xxx °C/xxx °F]**

The onboard hardware monitor automatically detects and displays the motherboard and CPU temperatures.

**CPU Fan Speed [xxxxRPM] or [N/A]**

**Chassis Fan Speed [xxxxRPM] or [N/A]**

The onboard hardware monitor automatically detects and displays the CPU and chassis fan speeds in rotations per minute (RPM). If any of the fans is not connected to the motherboard, the specific field shows N/A.



## VCORE Voltage, +3.3V Voltage, +5V Voltage, +12V Voltage

The onboard hardware monitor automatically detects the voltage output through the onboard voltage regulators.

### Smart Q-Fan Function [Disabled]

Enables or disables the ASUS Q-Fan function. Configuration options: [Disabled] [Enabled]

### Q-FAN Mode [Standard]

Sets the Q-Fan mode. This item appears only when the Smart Q-Fan Function item is Enabled. Configuration options: [Quiet] [Standard] [Cool]

## 2.6 Boot menu

The Boot menu items allow you to change the system boot options. Select an item then press <Enter> to display the sub-menu.

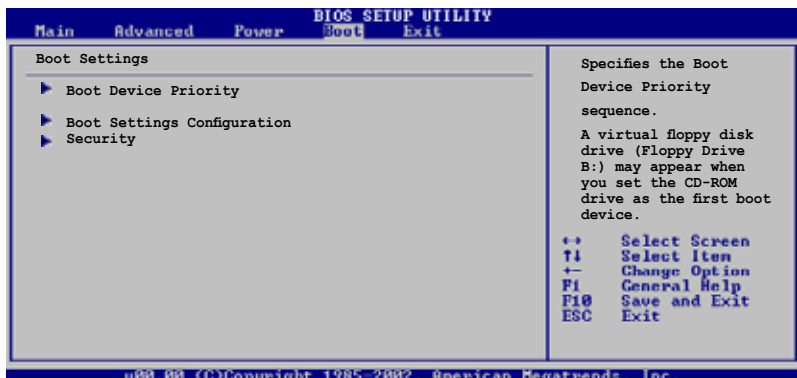

## 2.6.1 Boot Device Priority

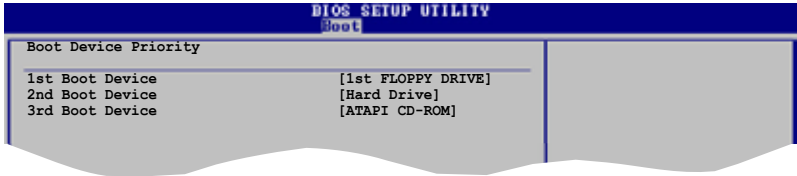

### 1st ~ xxth Boot Device [1st Floppy Drive]

These items specify the boot device priority sequence from the available devices. The number of device items that appear on the screen depends on the the number of devices installed in the system. Configuration options: [1st FLOPPY DRIVE][Hard Drive][ATAPI CD-ROM][Disabled]

## 2.6.2 Boot Settings Configuration

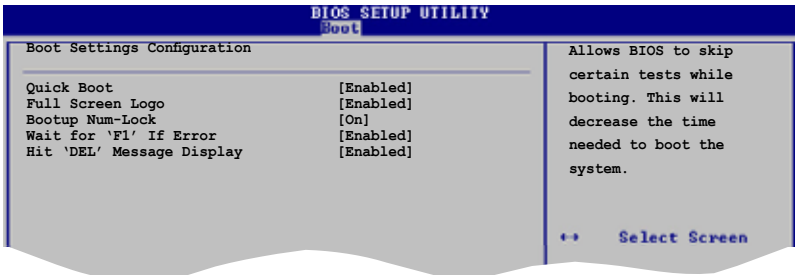

### Quick Boot [Enabled]

Enabling this item allows the BIOS to skip some Power On Self Tests (POST) while booting to decrease the time needed to boot the system. When set to [Disabled], BIOS performs all the POST items. Configuration options: [Disabled] [Enabled]

### Full Screen Logo [Enabled]

Allows you to enable or disable the full screen logo display feature. Configuration options: [Disabled] [Enabled]



Make sure that the above item is set to [Enabled] if you wish to use the ASUS MyLogo™ feature.

## Bootup Num-Lock [On]

Allows you to select the power-on state for the NumLock.  
Configuration options: [Off] [On]

## Wait for 'F1' If Error [Enabled]

When set to Enabled, the system waits for F1 key to be pressed when error occurs. Configuration options: [Disabled] [Enabled]

## Hit 'DEL' Message Display [Enabled]

When set to Enabled, the system displays the message "Press DEL to run Setup" during POST. Configuration options: [Disabled] [Enabled]

## 2.6.3 Security

The Security menu items allow you to change the system security settings. Select an item then press <Enter> to display the configuration options.

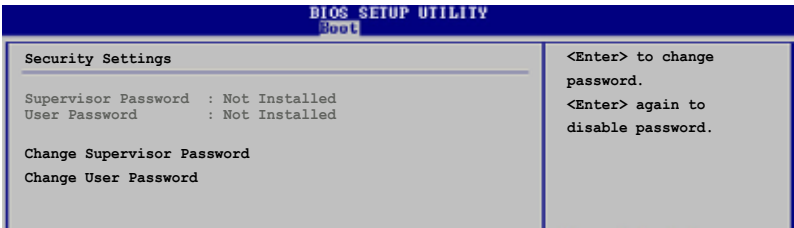

### Change Supervisor Password

Select this item to set or change the supervisor password. The Supervisor Password item on top of the screen shows the default Not Installed. After you have set a password, this item shows Installed.

To set a Supervisor Password:

1. Select the Change Supervisor Password item and press <Enter>.
2. From the password box, type a password combination of at least six (6) letters and/or numbers, then press <Enter>.
3. Confirm the password when prompted. The message "Password Installed" appears after you have successfully set your password. The Supervisor Password item now shows Installed.

To change the supervisor password, follow the same steps as in setting a user password.

To clear the supervisor password, select the Change Supervisor Password then press <Enter>. The message "Password Uninstalled" appears.



If you forget your BIOS password, you can clear it by erasing the CMOS Real Time Clock (RTC) RAM. See section “1.9 Jumpers” for information on how to erase the RTC RAM.

After you have set a supervisor password, the other items appear to allow you to change other security settings.

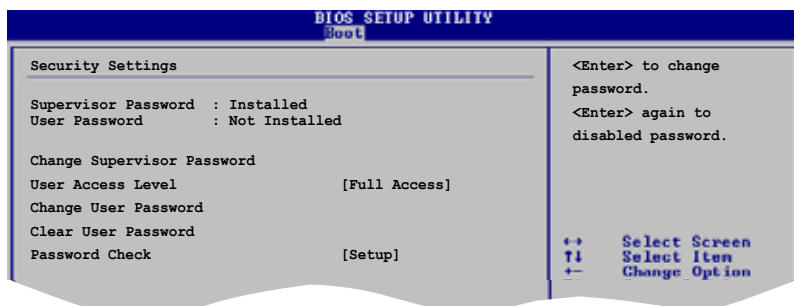

## User Access Level (Full Access)

Allows you to select the access restriction to the Setup items.

Configuration options: [No Access] [View Only] [Limited] [Full Access]

**No Access** prevents user access to the Setup utility.

**View Only** allows access but does not allow change to any field.

**Limited** allows change only to selected fields, such as Date and Time.

**Full Access** allows viewing and changing all the fields in the Setup utility.

## Change User Password

Select this item to set or change the user password. The User Password item on top of the screen shows the default Not Installed. After you have set a password, this item shows Installed.

To set a User Password:

1. Select the Change User Password item and press <Enter>.
2. On the password box that appears, type a password combination of at least six (6) letters and/or numbers, then press <Enter>.
3. Confirm the password when prompted. The message “Password Installed” appears after you have successfully set your password. The User Password item now shows Installed.

To change the user password, follow the same steps as in setting a user password.

## Clear User Password

Select this item if you wish to clear the user password.

## Password Check [Setup]

When set to [Setup], BIOS checks for user password when accessing the Setup utility. When set to [Always], BIOS checks for user password both when accessing Setup and booting the system. Configuration options: [Setup] [Always]

## 2.7 Tools menu



### 2.7.1 ASUS EZ Flash 2

Allows you to run ASUS EZ Flash 2. When you press <Enter>, a confirmation message appears. Use the left/right arrow key to select between [Ok] or [Cancel], then press <Enter> to confirm your choice.

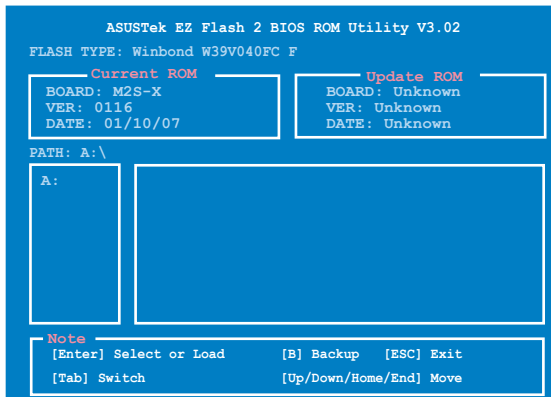

## 2.8 Exit menu

The Exit menu items allow you to load the optimal or failsafe default values for the BIOS items, and save or discard your changes to the BIOS items.

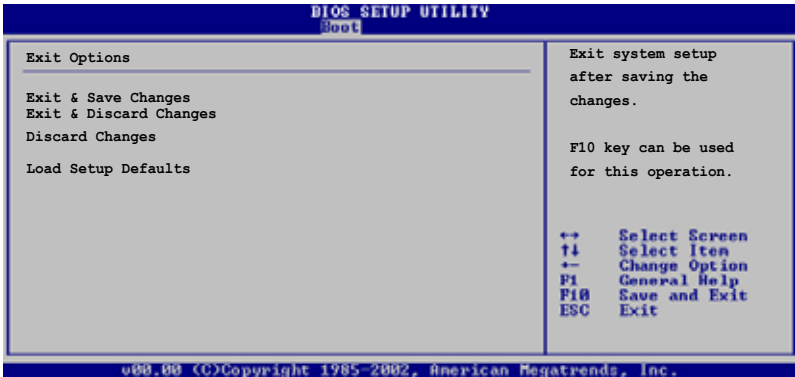

Pressing <Esc> does not immediately exit this menu. Select one of the options from this menu or <F10> from the legend bar to exit.

### Exit & Save Changes

Once you are finished making your selections, choose this option from the Exit menu to ensure that the values you selected are saved to the CMOS RAM. An onboard backup battery sustains the CMOS RAM and stays on even when the PC is turned off. When you select this option, a confirmation window appears. Select **Ok** to save changes and exit.



If you attempt to exit the Setup program without saving your changes, the program prompts you with a message asking if you want to save your changes before exiting. Press <Enter> to save the changes while exiting.

## **Exit & Discard Changes**

Select this option only if you do not want to save the changes that you made to the Setup program. If you made changes to fields other than System Date, System Time, and Password, the BIOS asks for a confirmation before exiting.

## **Discard Changes**

Allows you to discard the selections you made and restore the previously saved values. After selecting this option, a confirmation appears. Select Ok to discard any changes and load the previously saved values.

## **Load Setup Defaults**

This option allows you to load the default values for each of the parameters on the Setup menus. When you select this option or if you press <F5>, a confirmation window appears. Select Ok to load default values. Select Exit & Save Changes or make other changes before saving the values to the non-volatile RAM.





This chapter describes the contents of the support CD that comes with the motherboard package.

# 3 Software support

---

### 3.1 Install an operating system

This motherboard supports Windows® 2000/XP/Vista operating system (OS). Always install the latest OS version and corresponding updates to maximize the features of your hardware.



Motherboard settings and hardware options vary, so use the setup procedures presented in this chapter for general reference only. Refer to your OS documentation for more information.

### 3.2 Support CD information

The support CD that came with the motherboard contains useful software and several utility drivers that enhance the motherboard features.



The contents of the support CD are subject to change at any time without notice. Visit the ASUS website for updates.

#### 3.2.1 Running the support CD

To begin using the support CD, simply insert the CD into your CD-ROM drive. The CD automatically displays the **Drivers** menu if Autorun is enabled in your computer. Click on an item to install.



Click an item to install

Click an icon to display more information



If **Autorun** is NOT enabled in your computer, browse the contents of the support CD to locate the file **ASSETUP.EXE** from the **BIN** folder. Double-click the **ASSETUP.EXE** to run the CD.

## 3.2.2 Drivers menu

The drivers menu shows the available device drivers if the system detects installed devices. Install the necessary drivers to activate the devices.

### **ASUS Install-Installation Wizard for Drivers**

Installs all the drivers through the ASUS Installation Wizard.

### **AMD Cool 'n' Quiet Driver**

Installs the AMD Cool 'n' Quiet! technology drivers.

### **SIS RAID Controller Driver**

Install the SIS RAID Controller drivers.

### **SiS191/SiS190 Ethernet Driver**

Installs the SiS191/SiS190 Ethernet driver.

### **C-Media CM6501 Audio Driver**

Installs the C-Media CM6501 Audio driver and application.

## 3.2.3 Utilities menu

The Utilities menu shows the applications and other software that the motherboard supports.



## **ASUS PC Probe II**

This smart utility monitors the fan speed, CPU temperature, and system voltages, and alerts you on any detected problems. This utility helps you keep your computer at a healthy operating condition.

## **ASUS Update**

This program allows you to download the latest version of the BIOS from the ASUS website. Before using the ASUS Update, make sure that you have an Internet connection so you can connect to the ASUS website. Installing ASUS Update also installs ASUS Mylogo™.

## **ASUS Screen Saver**

Installs the ASUS screen saver.

## **ASUS Cool'n'Quiet Utility**

Installs the ASUS AMD Cool 'n' Quiet utility.

## **Acrobat Reader**

Installs the Adobe Acrobat® Reader V7.0. The Acrobat® Reader software is for viewing files saved in Portable Document Format (PDF).

## **Microsoft DirectX 9.0 Driver**

Installs the Microsoft DirectX™9.0c driver.

## **Anti-virus utility**

The anti-virus application detects and protects your computer from viruses that destroys data.

### 3.2.4 Make Disk



#### **Make SIS RAID Controller Driver Disk**

Creates the SIS RAID controller driver disk.

### 3.2.5 Manual



#### **SIS965/SIS965L SATA RAID User's Manual**

Allows you to open the SIS965/SIS965L Serial ATA RAID user's manual.

### 3.2.6 ASUS Contact Information

Clicking the ASUS Contact Information tab displays as stated. You may also find this information on the inside front cover of this user guide.

